



Marking, coding and systems solutions

# Baked goods & cereal

 **VIDEOJET**<sup>®</sup>



**We know the unique challenges you face on your production lines.**

**From harsh production environments to multiple products and packaging types to tight profit margins that drive the need for operational efficiency, we've developed solutions to address each of these issues.**

# When your ovens are on, your packaging printers need to be running too.

## In the baked goods industry, Videojet can solve virtually any coding and marking challenge.

Whatever you're baking – from bread and cookies to cakes and cereals – and wherever you need to accurately code information – from bread bags and pouches to cartons and cases – partnering with Videojet offers you these key efficiency, operational and financial advantages:

### Uptime advantage

All our innovations are designed and engineered to give you what we call the uptime advantage. We know continuous baking processes cannot stop for downstream issues, so keeping lines running is mission critical. Fresh products combined with narrow profit margins do not allow for unplanned stops.

### Code Assurance

Even if you're running multiple product and packaging types on a single line, our Code Assurance innovations don't just mean getting your coding right. They make getting it wrong virtually impossible. So whatever your production and coding challenges, our solutions enable you to overcome them.

### Built-in productivity

Our solutions are simply more available, more of the time. Whether your production facilities are hot, dusty and dry, freezing cold or soaking wet, we enable you to maximize your line efficiency and minimize your cost of ownership.

### Simple usability

The extensive Videojet product line could not be faster or simpler for your team to integrate onto your lines and master. The result? Your operators spend less time interacting with the printing equipment and more time focusing on production.



## Coding technologies for your packaging type:

Packaging Type	CIJ	TIJ	Laser	TTO	LPA	LCM
Bread Bag	✓			✓		
Bread Closure	✓		✓	✓		
Flow Pack	✓		✓	✓		
Bag/Pouch	✓			✓		
Carton	✓	✓	✓			
Case		✓	✓		✓	✓

# Multiple package types, six technologies, one name - Videojet

## Coding technologies

Baked goods and cereal companies around the world work with a variety of packaging and closure types, each bringing their own requirements and challenges. Videojet offers you a full suite of coding solutions to mark your products reliably, safely and efficiently, even in tough production environments.



### Continuous Inkjet (CIJ)

Fluid based, non-contact printing of up to five lines of text, linear and 2D bar codes, or graphics, printed on a variety of packaging types including stationary packaging via traversing systems.



### Thermal Inkjet (TIJ)

Ink-based, non-contact printing using heat and surface tension to move ink onto a package surface. Generally used to print 2D DataMatrix and other bar codes.



### Laser Marking Systems

A beam of infrared light focused and steered with a series of carefully controlled small mirrors to create marks where the heat of the beam interacts with the packaging surface.



### Thermal Transfer Overprinting (TTO)

A digitally controlled printhead precisely melts ink from a ribbon directly onto flexible films to provide high resolution, real-time prints.



### Label Printer Applicator (LPA)

Prints and places labels of various sizes on multiple package types.



### Large Character Marking (LCM)

Ink-based, non-contact printing of multiple data types (alphanumeric, logos and bar codes) in large sizes primarily used for secondary packaging such as cases.

# Innovative solutions for every step of your process

## Bread bagger and closure system

The use of preformed bread bags lends itself to a select group of coding technologies. The simple solution is to integrate on your conveyor to allow for bag marking after each product has been sealed and closed.

The type of closure you use determines whether it is possible to print on it and what technology should be chosen to perform the task. For optimal results, the printer should be integrated directly with the closure system.

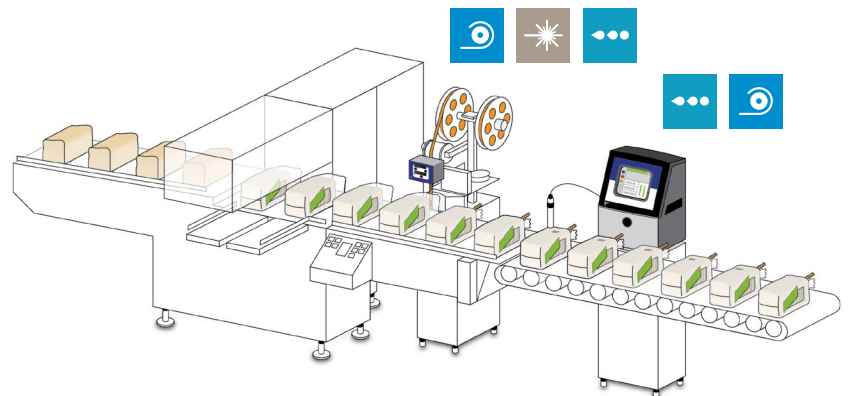

## Flow wrapper

Videojet has several solutions for flow wrapping applications regardless of your line speeds. Although coding downstream of the flow wrapper is possible, the highest quality codes are typically obtained by printing on the film prior to packaging.

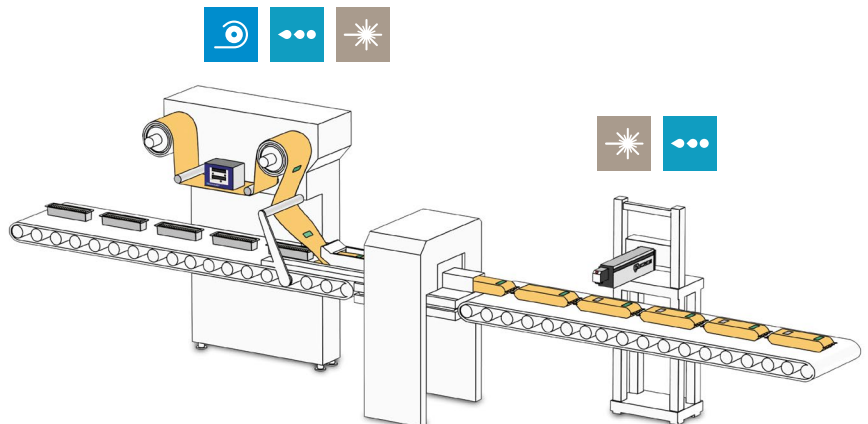

# Innovative solutions for every step of your process

## Vertical form fill seal

Whether intermittent or continuous motion, Videojet has a range of printers to address the growing complexity of VFFS bags and pouches. Packaging features, like zippers and gussets, require a thoughtful selection of the right coding technology.

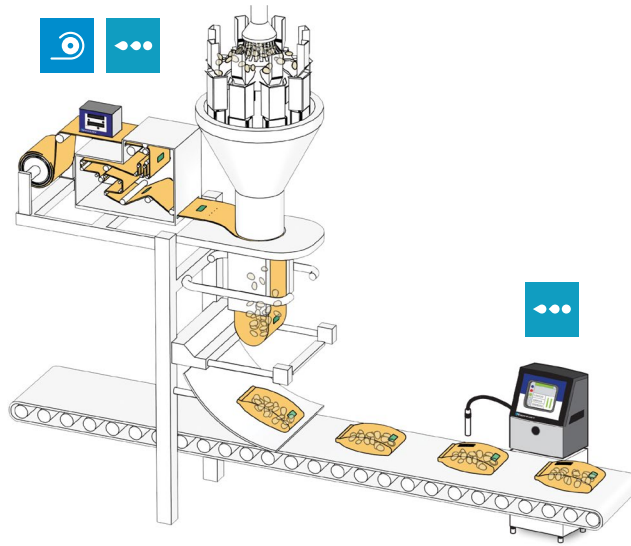

## Cartoner

Traditionally good material handling enables a range of technologies either integrated with the machine or immediately downstream in the outfeed. The optimal installation location will depend upon the size constraints of both the cartoner and the preferred coding technology.

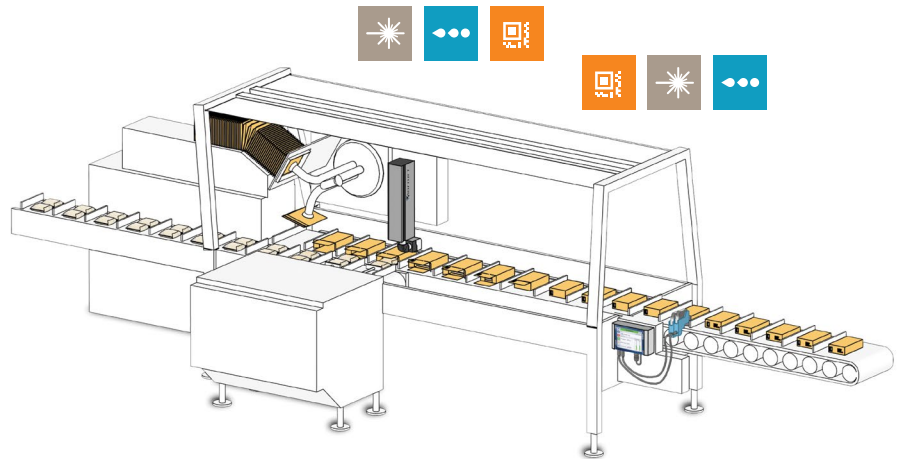

## Case packer and sealer

Printers are best integrated on your conveyor after the sealed case has been discharged. The type and amount of information you want to print on your cases determines which of our solutions is ideal for you.

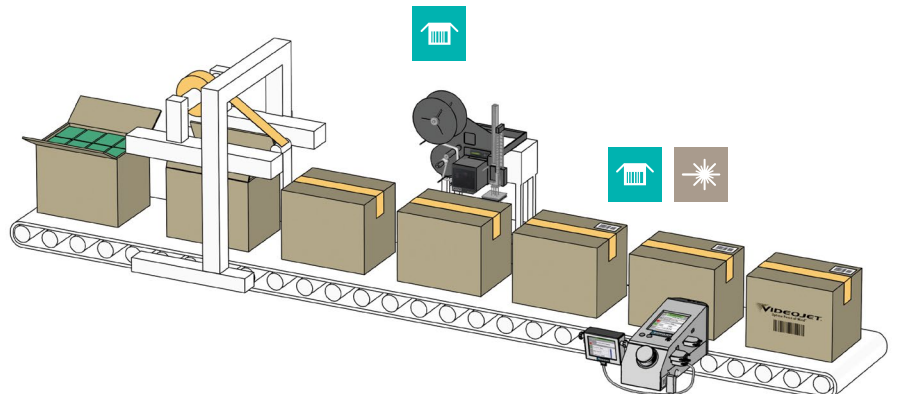

## Flow pack coding

# Keep pace with flow wrapping technology

Innovations in packaging equipment and industry trends are resulting in increasing flow wrapping speeds. You'll want to take advantage of this growing capability for higher throughput and enjoy the effect it has on profitability. But cost-effective, high quality coding is still a necessity and not all printers are created equal. In fact, Videojet has matched these innovations in packaging speeds with a range of coding options. Videojet can help you feel confident that your entire message will appear clearly and in the right space on the product, while still keeping your lines running.

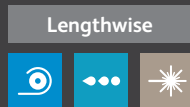

**Widthwise and lengthwise**

### Thermal Transfer Overprinting (ТТО)

- produces high resolution codes on flexible film without solvents
- integrates directly into the line and prints on the film prior to packaging the product
- ideal for printing dates, logos, bar codes, nutrition facts, other product information and graphics

**Lengthwise**

### Continuous Inkjet (CIJ)

- meets the needs of high speed flow wrapping applications
- coding will be applied either before or after the product has been packaged
- code changes are simple through a user-friendly message creation interface or connection to networking software

**Lengthwise**

### Laser Marking Systems

- creates clear, consistent and permanent codes with limited consumables
- integrate directly with the flow wrapper to ensure more consistent placement of the code
- ideal for pre-printed polypropylene films as the laser can remove the ink without damaging the film

## Bread bag coding

# A more permanent code with clear options

While many bakeries choose to code on bread closures, coding on bread bags can ensure a more permanent and visible code as consumers may remove the closure, losing the code on it. However, the light poly preformed bags can only be coded on after the bag has been filled and closed and is on the conveyor. In addition, this packaging material tends to melt when hot methods of coding are used on it. Our printers address these concerns.

Bread bag closure



## The perfect code, perfectly positioned

Getting a CIJ code on a bread bag can be difficult. Crinkling or too much air in the bag can ruin a code. Dark breads may also make a code on the bag difficult to read.

Simple solutions, such as adding a metal guide to flatten the bag, help deliver consistent and high quality coding while printing a code on a light colored pre-printed rectangle provides appropriate contrast with ink to avoid obscuring the code on a bag with dark bread as the background.

Top of bag



Front of bag



Top and front of bag



### Continuous Inkjet (CIJ)

- versatile coding method for irregular or curved surfaces such as bread bags
- non-contact coding maintains product and packaging integrity
- variety of specialty inks including odorless and non-MEK inks

Top and front of bag



### Thermal Transfer Overprinting (TTO)

- most commonly integrated with a label applicator
- can include both variable and static information such as bar codes, sell by date and price
- Code Assurance features help reduce coding errors



## Bread bag coding

# Not all closures are created equal

Special closures have been designed to seal preformed bags to ensure the freshness of the product, for consumer friendly use and to provide an area for marking sell by dates. We offer you three proven solutions.



## Global solutions for localized applications

While bread in preformed bags is a common sight around the world, the type of closure used can vary from country to country and even within regions of a country. Twist ties, tamper evident tape and plastic clips are the most common closures. Additionally, the location of the code is variable. Depending on where you are in the world, bread may be coded on the bag, on the closure or both. Whatever your location and requirements, Videojet offers you a coding solution.

### Bread bag closure



#### Continuous Inkjet (CIJ)

- suitable for most closures
- most effective when used to print a single line, such as a simple date code
- range of inks for different closure materials

### Bread bag closure



#### Thermal Transfer Overprinting (TTO)

- simple, direct contact coding
- allows for more information to be printed on tamper evident tape than other coding technologies

### Bread bag closure



#### Laser Marking Systems

- ideal for crisp, clear and permanent coding
- testing on your closure is critical before you purchase a laser for this application

## Bag and pouch coding

# Get more from your printer

Managing multiple pre-printed films for multiple products running on the same line can be cumbersome and costly. TTO gives you the capability to print product information during packaging and variabilize mark content to limit pre-printed film variations. TTO can print high resolution logos, bar codes and product information, giving you the ultimate in flexibility and efficiency.

### Product information



### Standard code



#### Product information and standard code



### Thermal Transfer Overprinting (TTO)

- directly integrates with vertical form fill seal machines (VFFS) to produce high quality codes
- work with an experienced partner as space to integrate on these machines can be limited
- suitable to print on lines with intermittent or continuous motion

#### Standard code



### Continuous Inkjet (CIJ)

- particularly useful for coding on more complicated applications such as preformed pouches and bags with very thick resealable zippers
- can seamlessly integrate with your VFFS equipment to take advantage of the material handling of the film

## Carton coding

# The benefits of integration

Coders are integrated either directly with a cartoner or on the outfeed conveyor after the carton has been filled and sealed. Although integration directly with the cartoner can require more planning, it offers you considerable benefits. These include more consistent coding due to more precise material handling and the use of existing guards on the machine. These advantages are similar for other types of packaging machinery.



Top of carton

Side of carton



Top and side of carton



### Laser Marking Systems

- simple and clean method of marking text, bar codes or images while utilizing virtually no consumables
- a CO<sub>2</sub> laser will remove a top layer of pre-printed ink to expose the layer underneath, resulting in a high quality, bright code against the dark background

Top and side of carton



### Thermal Inkjet (TIJ)

- high quality ink-based printing solution that works best with either porous carton materials or in a print window that masks the aqueous overcoat
- prints at a higher resolution than other ink-based systems
- ideal for printing multiple lines of text, bar codes and other complex data

Top and side of carton



### Continuous Inkjet (CIJ)

- a versatile coding method
- codes adhere to virtually all common carton materials, including those with aqueous overcoats and other varnishes
- colored inks can be used to create contrast on different colored cartons

## Coding on cases

# The case for accurate coding

Getting legible and accurate information on your cases is vital to you effectively identifying and moving your goods through your supply chain. We have multiple solutions to offer, from simple text information printed directly on the case to high resolution labelling applied automatically. The right solution will depend on your needs. We've outlined the options below.



## Case coding improves supply chain efficiency and reduces costs

Printing lot, batch and supplier-specific information clearly on your cases creates a traceability point visible to your warehouse, wholesaler and retailer, thus providing rapid identification to aid effective movement of your products. Additionally, printing this information directly on the case simplifies packaging demands by standardizing to a common box style for different trading partners.



Direct to case



Direct to label



### Direct to case



## Large Character Marking (LCM)

- prints information directly on the case including scannable bar codes
- very cost-effective and dependable
- eliminates the cost, stocking and management of labels, as well as the need for customer-specific pre-printed cases

### Direct to label



## Label Print & Apply (LPA)

- high quality thermal transfer coding direct to the label
- delivers high resolution text and bar codes
- labels can be configured at the printer via an easy-to-use menu
- automatic application offers greater speed, accuracy and error prevention than hand labelling

### Direct to case



## Laser Marking Systems

- a DataLase® coated case marked with a laser will produce a dark black and extremely high resolution print
- prints graphics, multisized text and bar codes directly onto corrugated boxes
- especially useful for water-resistant coated boxes, as it enables clear, dark printing without damage to the protective coating

## Supplies & accessories

# Customized solutions for your application

Every coding application is different. That is why we offer one of the most comprehensive selections of supplies and accessories in order to customize our solution for your unique application. For example, with the broadest portfolio of CIJ inks and the industry's leading team of ink application chemists, Videojet has spent over 40 years developing specialty formulations ideal for baked goods and cereal applications. We also work directly with the major OEMs and have a wide range of accessories for each printing technology to seamlessly integrate our printers into your production lines.

## Supplies

### Specially developed inks and fluids

- formulated for most types of flexible films and cartons
- high performance in hot and cold production environments
- odorless and non-MEK inks



### Advanced TTO ribbons

- advanced backcoat technology for higher image quality and for protection and extension of printhead life
- wide variety of colors

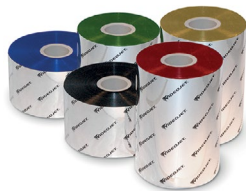

## Accessories

### Customized accessories for almost any application

- dual head CIJ printers and traversing systems
- stainless steel brackets, sealed rubber rollers and platens for TTO applications
- fume extractors, beam turning units and beam shields for laser applications and integration



# Peace of mind comes as standard

Videojet Technologies is a world-leader in the product identification market, providing in-line printing, coding, and marking products, application specific fluids, and product life cycle services.

Our goal is to partner with our customers in the consumer packaged goods, pharmaceutical, and industrial goods industries to improve their productivity, to protect and grow their brands, and to stay ahead of industry trends and regulations. With our customer application experts and technology leadership in Continuous Inkjet (CIJ), Thermal Inkjet (TIJ), Laser Marking, Thermal Transfer Overprinting (TTO), case coding and labeling, and wide array printing, Videojet has more than 400,000 printers installed worldwide.

Our customers rely on Videojet products to print on over ten billion products daily. Customer sales, application, service and training support is provided by direct operations with over 4,000 team members in 26 countries worldwide. In addition, Videojet's distribution network includes more than 400 distributors and OEMs, serving 135 countries.

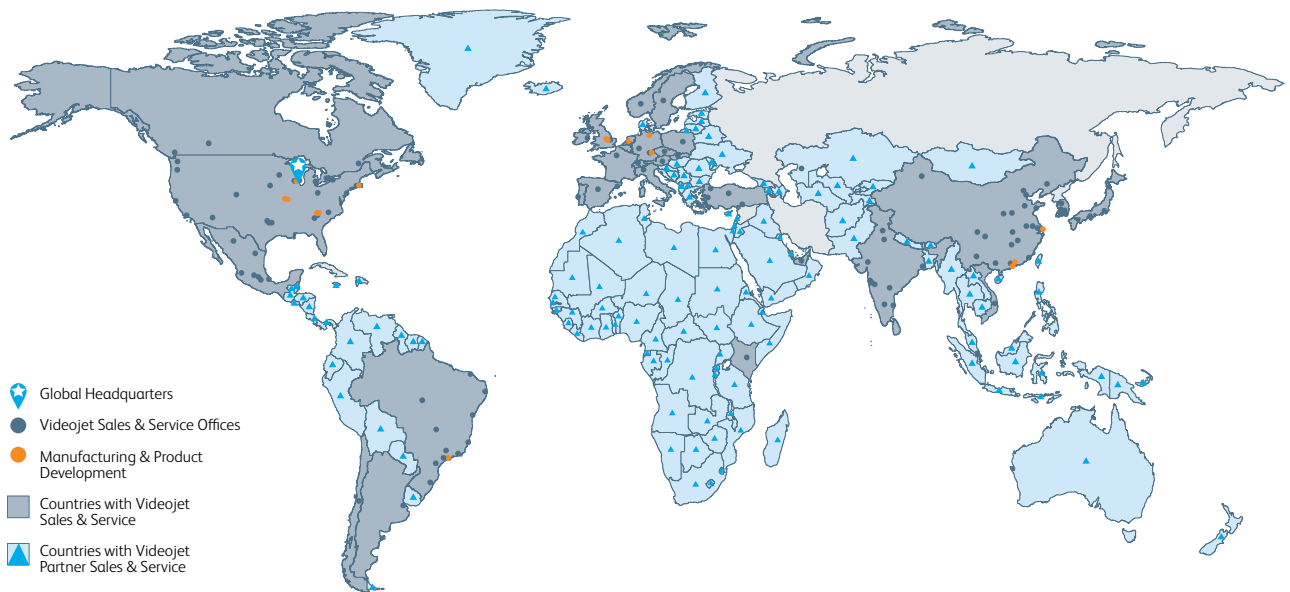

Call **800-843-3610**  
Email **info@videojet.com**  
or visit **www.videojet.com**

Videojet Technologies Inc.  
1500 Mittel Blvd. Wood Dale IL 60191 / USA

©2023 Videojet Technologies Inc. All rights reserved.  
Videojet Technologies Inc.'s policy is one of continued product improvement.  
We reserve the right to alter design and/or specifications without notice.

Part No. SL000566  
Bakery/Cereal-0723  
Printed in U.S.A.

