



# Videojet 1220/1520 Operator Manual

P/N 462268-01

Revision AA, July 2011

Copyright July 2011, **Videojet Technologies Inc.** (herein referred to as **Videojet**). All rights reserved.

This document is the property of **Videojet Technologies Inc.** and contains confidential and proprietary information owned by **Videojet**. Any unauthorized copying, use or disclosure of it without the prior written permission of **Videojet** is strictly prohibited.

---

**Videojet Technologies Inc.**

1500 Mittel Boulevard  
Wood Dale, IL  
60191-1073 USA  
[www.videojet.com](http://www.videojet.com)

Phone: 1-800-843-3610  
Fax: 1-800-582-1343  
Int'l Fax: 630-616-3629

**Offices** - USA: Atlanta, Chicago, Los Angeles, Philadelphia  
INT'L: Canada, France, Germany, Ireland, Japan, Spain,  
Singapore, The Netherlands, The United Kingdom  
**Distributors Worldwide**

# Compliance Information

---

## For Customers in the European Union

This equipment displays the CE mark to indicate conformance to the following legislation:

<b>EN55022:2006 + A1:2007 Class A</b>	Emissions Standard for industrial environments
<b>EN61000-6-4 2007</b>	Generic Emissions Standard for Heavy Industrial Environments
EN61000-3-2 2006	Harmonic Current Fluctuations
EN61000-3-3 2008	Voltage Fluctuation and Flicker
<b>EN61000-6-2 2005</b>	Immunity Characteristics for Industrial Environments

Following the provisions of **EU EMC Directive 2004/108/EC**

### **EC Low Voltage Directive 2006/95/EEC**

Essential health and safety requirements relating to electrical equipment designed for use within certain voltage limits.

### **IEC 60950-1:2001**

Safety requirements for information technology equipment including electrical business equipment.

### **EN 60529:1991**

Degrees of protection provided by enclosures (IP code).

## For Customers in the U.S.A.

This device complies with Part 15 of the FCC Rules. Operation is subject to the following two conditions: 1) this device may not cause harmful interference, and 2) this device must accept any interference received, including interference that may cause undesired operation.



### **Warning**

Changes or modifications to this unit not expressly approved by the party responsible for compliance could void the user's authority to operate the equipment.

---

This equipment has been tested and found to comply with the limits for a Class A digital device, pursuant to Part 15 of the FCC Rules. These limits are designed to provide responsible protection against harmful interference when the equipment is operated in a commercial environment. This equipment generates, uses, and can radiate radio frequency energy and, if not installed and used in accordance with the instruction manual, may cause harmful interference to radio

communications. Operation of this equipment in a residential area is likely to cause harmful interference in which case the user will be required to correct the interference at his own expense.

Shielded cables must be used with this unit to ensure compliance with Class A FCC limits.

The user may find the following booklet prepared by the Federal Communications Commission helpful: How to Identify and Resolve Radio-TV Interference Problems. This booklet is available from the U.S. Government Printing Office, Washington, DC 20402, Stock No. 004-00-00345-4.

This equipment has been tested and certified for compliance with U.S. regulations regarding safety and electrical emissions by:

Electromagnetic Testing Services Limited

Pratts Fields

Lubberhedges Lane

Stebbing, Dunmow

Essex, CM6 3BT

England, UK

This equipment has been investigated by Underwriters Laboratories Inc. in accordance with the standard for safety: UL 60950-1: Safety of information technology equipment first edition. Subject 2178 marking and coding equipment, electronics.

Report reference E252185.

### **For Customers in Canada**

This digital apparatus does not exceed the Class A limits for radio noise emissions from digital apparatus set out in the Radio Interference Regulations of the Canadian Department of Communications.

This equipment has been tested and certified for compliance with Canadian regulations regarding safety and electrical emissions by:

Electromagnetic Testing Services Limited

Pratts Fields

Lubberhedges Lane

Stebbing, Dunmow

Essex, CM6 3BT

England, UK

This equipment has been investigated by Underwriters Laboratories Incorporated in accordance with the standard for safety: CAN/CSA C22.2 No. 60950-1-03. Safety of information technology equipment. Subject 2178 marking and coding equipment, electronics.

Report reference E252185.

### **Pour la clientèle du Canada**

Le présent appareil numérique n'émet pas de bruits radioélectriques dépassant les limites applicables aux appareils numériques de la classe A prescrites dans le Règlement sur le brouillage radioélectrique édicté par le ministère des Communications du Canada.

Cet équipement est certifié CSA.

This equipment has been investigated by Underwriters Laboratories Incorporated in accordance with the standard for safety: CAN/CSA C22.2 No. 60950-1-03. Safety of information technology equipment. Subject 2178 marking and coding equipment, electronics.

Report reference E252185.



### **Warning**

This product is not intended for use in the immediate/direct visual field of the display work place. To avoid disturbing reflections on the display work place, this product shall not be placed in the immediate/direct field of vision.

---

# Customer Support and Training

---

## Contact Information

If you have any questions or need assistance, please contact Videojet Technologies Inc. at 1-800-843-3610 (for all customers within the United States). Outside the U.S., customers should contact their Videojet Technologies Inc. distributor or subsidiary for assistance.

Videojet Technologies Inc.

1500 Mittel Boulevard

Wood Dale, IL 60191-1073 U.S.A.

Phone: 1-800-843-3610

Fax: 1-800-582-1343

International Fax: 630-616-3629

Web: [www.videojet.com](http://www.videojet.com)

## Service Program

### About **Total Source Commitment**

*Total Source*® TOTAL SERVICE PLUS RELIABILITY, is the Videojet Technologies Inc. commitment to provide you - our customer - the complete service you deserve.

### The **Total Source Commitment**

The Videojet *Total Source*® Service Program is an integral part of our business in providing marks, codes, and images where, when, and how often customers specify for packages, products, or printed materials. Our commitment includes:

- Applications support.
- Installation services.
- Maintenance training.
- Customer response center.
- Technical support.
- Field service.
- Extended hours phone assistance.
- Parts and supplies.
- Repair service.

## Customer Training

If you wish to perform your own service and maintenance on the printer, Videjet Technologies Inc. highly recommends you complete a Customer Training Course on the printer.

*Note: The manuals are intended to be supplements to (and not replacements for) Videjet Technologies Inc. Customer Training.*

For more information on Videjet Technologies Inc. Customer Training Courses, call 1-800-843-3610 (within the United States only). Outside the U.S., customer should contact a Videjet subsidiary office or the local Videjet distributor for further information.

# Table of Contents

<i>Compliance Information</i>	
<i>For Customers in the European Union</i> . . . . .	<i>i</i>
<i>For Customers in the U.S.A.</i> . . . . .	<i>i</i>
<i>For Customers in Canada</i> . . . . .	<i>ii</i>
<i>Pour la clientèle du Canada</i> . . . . .	<i>iii</i>

<i>Customer Support and Training</i>	
<i>Contact Information</i> . . . . .	<i>iv</i>
<i>Service Program</i> . . . . .	<i>iv</i>
<i>Customer Training</i> . . . . .	<i>v</i>

## **Chapter 1 — Introduction**

Videojet 1220/1520 Printer . . . . .	1-1
About the Manual. . . . .	1-1
Related Publications. . . . .	1-1
Language Codes. . . . .	1-1
Content Presentation . . . . .	1-3
Positional References. . . . .	1-3
Units of Measurement. . . . .	1-3
Safety Information . . . . .	1-3
Warning. . . . .	1-3
Caution . . . . .	1-3
Notes . . . . .	1-4
User Interface Terminology . . . . .	1-4
Abbreviations and Acronyms. . . . .	1-6
Chapters in the Manual . . . . .	1-6

## **Chapter 2 — Safety**

Introduction. . . . .	2-1
General Safety Guidelines. . . . .	2-1
Electrical Safety Guidelines. . . . .	2-2
Electrical Power Supply . . . . .	2-2
Electrical Cables . . . . .	2-3
Grounding and Bonding. . . . .	2-3
Fuses . . . . .	2-5
Fluid Safety Guidelines . . . . .	2-5
Read the Material Safety Data Sheets . . . . .	2-5
Ink and Make-up Fluid . . . . .	2-6
Cleaning Solution. . . . .	2-7
Compressed Air Safety Guidelines . . . . .	2-8
UI Related Safety Guidelines . . . . .	2-8



Other Important Guidelines .....2-9

**Chapter 3 — Main Parts**

Videjet 1220/1520 Printer .....3-1

Control Panel.....3-3

    Status LEDs.....3-3

    Arrow Keys.....3-4

    Keypad.....3-4

    Display.....3-4

    Contrast Keys.....3-4

    Function Keys.....3-4

    Display Screen.....3-5

Electronics Compartment .....3-6

Ink Compartment .....3-8

    Ink Core Module.....3-8

    Smart Cartridge .....3-9

    Ink Compartment Fan.....3-9

Printhead and Umbilical .....3-9

Connector Panel .....3-11

    Pinout Information.....3-12

Main Power Switch.....3-13

Back Filter.....3-13

**Chapter 4 — Printer Operation**

Introduction.....4-1

How to Turn on the Printer.....4-1

How to Clean Start and Stop the Printer.....4-2

    How to Clean Start.....4-2

    How to Clean Stop.....4-2

How to Set the Passwords.....4-2

    How to Login for the First Time.....4-3

    How to Set the Passwords for Levels 1 and 2 .....4-3

    How to Set the Password Levels for Menus.....4-4

    How to Access Other Password Levels.....4-6

    How to Clear the Password.....4-6

    Auto Logout.....4-7

System Menu.....4-7

Calibrate Menu.....4-8

Data Logging Menu.....4-10

    How to View Version Information.....4-10

Product Counter.....4-11

    How to Reset the Product Counter.....4-11

How to Hide the Product Counter .....	4-11
Run Hours .....	4-12
How to View Run Hours .....	4-12
How to Reset Run Hours .....	4-12
How to Configure the Serial Port.....	4-13
How to Configure Ethernet Port .....	4-14
How to Enter Service Information.....	4-14
How to Create a Message .....	4-15
Printer Configuration.....	4-15
Print Enable.....	4-15
Manual Print Option .....	4-17
How to Use Continuous Print Option .....	4-17
DIN Print.....	4-18
How to Print Messages .....	4-18
How to Select a Message.....	4-19
How to Start the Printing .....	4-19
Monitor the Printing .....	4-20
How to Stop the Printing .....	4-20
How to Install and Print Custom Fonts .....	4-20
Installation .....	4-21
Create and Print a Message .....	4-21
Turn off the Printer.....	4-22

## **Chapter 5 — User Interface**

Introduction.....	5-1
To Select the Menus and Items .....	5-2
To Enter the Text, Numbers and Toggle Values.....	5-3
Menu Description.....	5-6
Messages .....	5-6
Editor .....	5-8
User Fields .....	5-9
Print .....	5-10
Password.....	5-11
System .....	5-12
Configure .....	5-13
Manage Messages.....	5-18
To Create a Message .....	5-18
To Edit a Message .....	5-20
To Select the Source for a Message .....	5-21
To Copy and Paste a Message .....	5-22
To Enter Multiple Lines in a Message.....	5-22
To Set the Message and Default Parameters .....	5-22
To Set Default Parameters .....	5-24

To Set Message Parameters . . . . .	5-24
To Clear a Message . . . . .	5-25
To Save a Message . . . . .	5-26
To Save a Message and Exit . . . . .	5-26
To Exit without Saving the Message . . . . .	5-27
To Delete a Message . . . . .	5-27
Manage User Fields . . . . .	5-28
To Insert a User Field . . . . .	5-30
To Insert a Pre-defined User Field . . . . .	5-31
To Edit a User Field . . . . .	5-32
To Delete a User Field . . . . .	5-33
To Create a Custom User Field . . . . .	5-33
To Set Text Attributes . . . . .	5-34
To Set a Counter . . . . .	5-37
To Add Logo . . . . .	5-38
To Reset a Message Counter . . . . .	5-39
To Set Shifts . . . . .	5-40
Manage Text . . . . .	5-42
To Change Font Case . . . . .	5-42
To Set Font Height . . . . .	5-42
To Select Content . . . . .	5-43
To Copy and Paste Text . . . . .	5-44
To Copy Text . . . . .	5-44
To Paste Text . . . . .	5-45
To Modify Text Attributes . . . . .	5-46
To Modify Attributes . . . . .	5-47
To Apply In-line Attributes . . . . .	5-48
To Insert a Barcode . . . . .	5-48
To Insert Foreign Language Characters . . . . .	5-50
Manage Logos . . . . .	5-50
To Download a Logo . . . . .	5-50
To Create a Logo in Microsoft Paint Application . . . . .	5-51
To Use the Logo Editor Menu . . . . .	5-53
To Set Logo Size . . . . .	5-53

**Chapter 6 — Maintenance**

Introduction . . . . .	6-1
Maintenance Schedule . . . . .	6-1
Preparation for Long-term Shutdown (Storage) or Transportation . . . . .	6-2
Parts/tools Requirement . . . . .	6-2
How to Prepare for Long-term Shutdown (Storage) or Transportation . . . . .	6-2
Replace Smart Cartridges . . . . .	6-4

Inspect the Printhead . . . . .	6-6
Clean the Printhead . . . . .	6-7
Clean the Deflector Plate. . . . .	6-10
Clean the Printer Cabinet . . . . .	6-11

## **Chapter 7 — Troubleshooting**

Introduction. . . . .	7-1
The Printer Does Not Start . . . . .	7-2
Incorrect Print Position . . . . .	7-3
Incorrect Print Size . . . . .	7-3
Print Not Complete . . . . .	7-4
Poor Print Quality . . . . .	7-4
Printer Status Icons. . . . .	7-5
Indicator Icons . . . . .	7-6
Fault (Alarm) Icons . . . . .	7-6
Warning Icons . . . . .	7-8
Ink Core Life . . . . .	7-12
Fault Messages . . . . .	7-13

## **Appendix A — Specifications**

Electrical Specifications . . . . .	A-1
Weight . . . . .	A-1
Dimensions . . . . .	A-2
Optional Accessories . . . . .	A-6
Mobile Printer Stand . . . . .	A-6
Static Printer Stand . . . . .	A-7
Printhead Stand . . . . .	A-8
Environmental Specifications. . . . .	A-8
Ink and Make-up Fluid Capacity . . . . .	A-9
Print Height. . . . .	A-9
Font Specifications and Line Speeds . . . . .	A-9
Barcode Specifications . . . . .	A-11

*Glossary*

## Videojet 1220/1520 Printer

This printer is a continuous ink jet printer that can print fixed and variable codes at elevated line speeds on consumer and industrial products. The printer delivers superior uptime, excellent print quality, and ease of use to the users.

## About the Manual

This Operator Manual is written for the every day user of the printer. The Operator Manual helps the user to understand the different parts and different printing operations of the printer.

## Related Publications

The following manual is available for reference:

Videojet 1220/1520 Service Manual, Part Number: 462272.

### Language Codes

When you order these manuals, make sure to add the 2-digit language code at the end of the part number. For example, the spanish version of the operator manual is part number 462268-04. Table 1-1 on page 1-2 shows the list of language codes that you can use to identify the translated versions of this manual.

*Note: The availability of the Operator Manual is indicated by an asterisk (\*). Availability of the Service Manual is indicated by a plus sign (+). For more information, contact the Videojet distributor or subsidiary.*

Code	Language	Availability (see note)	
01	English (US)	*	+
02	French	*	+
03	German	*	+
04	Spanish	*	+
05	Portuguese Brazilian	*	
06	Japanese	*	+
07	Russian	*	
08	Italian	*	
09	Dutch	*	
10	Chinese (Simplified)	*	+
11	Arabic	*	
12	Korean	*	+
13	Thai	*	
15	Norwegian	*	
16	Finnish	*	
17	Swedish	*	
18	Danish	*	
19	Greek	*	
20	Hebrew	*	
21	English (UK)	*	+
23	Polish	*	
24	Turkish	*	+
25	Czech	*	
26	Hungarian	*	
33	Vietnamese	*	
34	Bulgarian	*	
36	Chinese (Traditional)	*	
44	Romanian	*	

Table 1-1: List of Language Codes

Code	Language	Availability (see note)	
45	Macedonian	*	
46	Serbian	*	

Table 1-1: List of Language Codes (Continued)

## Content Presentation

This Operator Manual contains different types of information like, safety guidelines, additional notes, user interface (UI) terminology and so on. To help you identify the different types of information, different writing styles are used in this manual. This section describes these writing styles.

### Positional References

Positions and directions like left, right, front, rear, to the right and to the left are with respect to the printer when you see from the front.

### Units of Measurement

This manual uses metric units of measurement. The equivalent English measures are included in parenthesis. For example, 240 mm (9.44 inches).

### Safety Information

The safety information includes warning and caution statements.

#### Warning

The warning statements indicate hazards or unsafe practices that can cause severe personal injury or death. For example:



#### Warning

PERSONAL INJURY. The cleaning solution is poisonous if taken internally. Do not drink. Seek medical attention immediately if ingested.

#### Caution

The caution statements indicate hazards or unsafe practices that can cause damage to the equipment. For example:

 **Caution**

EQUIPMENT DAMAGE. Do not fit or remove any connector on the printer when the power is turned on. The failure to follow this caution can damage the printer.

**Notes**

Notes provide additional information about a particular topic.

For example:

*Note: You can set the password protection for some functions to prevent any access that is not authorised.*

**User Interface Terminology**

The UI elements are shown in italics. For example:

“Press Alt+M to select the *Messages* menu”. The word *Messages* is a UI element and is shown in italics (see Figure 1-1).

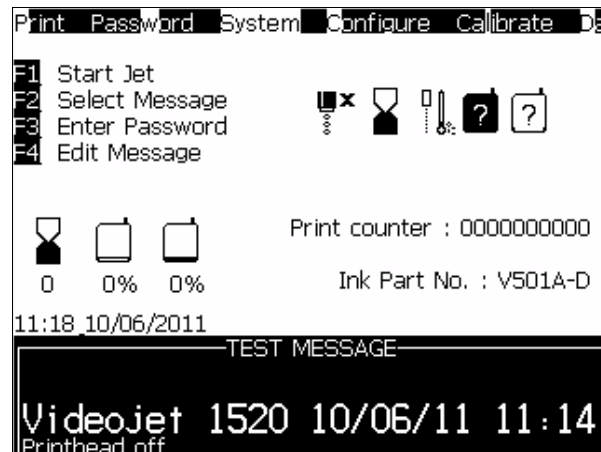

Figure 1-1. Menu Screen

The writing style used to indicate different keys on the control panel is shown in Table 1-2 on page 1-5.

















Key	Style Used
	Left arrow key
	Right arrow key
	Up arrow key
	Down arrow key
 	Enter key
 	Esc key
	F1 key
	F2 key
	F3 key
	F4 key
	Alt key
	Ctrl key
	Shift key

Table 1-2: Content Presentation Style for Keys

## Abbreviations and Acronyms

Abbreviation	Expansion
AC	Alternating Current
CDA	Clean Dry Air
LED	Light Emitting Diode
LCD	Liquid Crystal Display
UI	User Interface
WYSIWYG	What You See Is What You Get

Table 1-3: Abbreviations and Acronyms

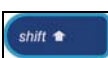
## Chapters in the Manual

Chapter No.	Chapter Name	Description
1.	Introduction	Contains the information about this manual, the related publications, and writing styles used in this manual
2.	Safety	Contains the safety and hazard information
3.	Main Parts	Describes the main parts of the printer
4.	Printer Operation	Contains the information on how to set up and operate the printer
5.	User Interface	Explains how to use the UI to create and save messages
6.	Maintenance	Contains the information on how to maintain and clean the printer
7.	Troubleshooting	Contains the operator level diagnostic and troubleshooting procedures
8.	Specifications	Contains printer specifications
9.	Glossary	Explains the printer related technical terms

Table 1-4: List of Chapters

## Introduction

The policy of Videojet Technologies Inc. is to manufacture non-contact printing/coding systems and ink supplies that meet high standards of performance and reliability. We enforce strict quality control techniques to eliminate potential defects and hazards in our products.

The intended use of the printer is to print information directly onto a product. Use of this equipment in any other fashion may lead to serious personal injury.

The safety guidelines provided in this chapter are intended to educate the operators on all safety issues so that the printer is serviced and operated in a safe manner.

## General Safety Guidelines

- Always refer to the correct service manuals as per the specific Videojet printer model for important details.
- Only Videojet-trained personnel must carry out installation and maintenance work. Any such work undertaken by unauthorized personnel may damage the printer and will invalidate the warranty.
- To avoid damage to the printer components, use only soft brushes and lint free cloths for cleaning. Do not use high pressure air, cotton waste, or abrasive materials.
- The printhead must be completely dry before attempting to start the printer, otherwise the printhead may get damaged.
- Do not fit or remove any connector on the printer when the power is turned on, otherwise the printer may get damaged.

## Electrical Safety Guidelines

This section explains the safety guidelines related to electrical power supply and electrical cables.

### Electrical Power Supply



#### Warning

PERSONAL INJURY. Lethal voltages are present within this equipment when it is connected to the mains electrical supply. Only trained and authorized personnel must carry out the maintenance work.

---



#### Warning

PERSONAL INJURY. Observe all statutory electrical safety codes and practices. Unless it is necessary to run the printer, disconnect the printer from the mains electrical supply before removing the covers or attempting any service or repair activity. Non-adherence to this warning can result in death or personal injury.

---



#### Warning

PERSONAL INJURY. A high AC voltage is present at the inverter and backlight. Extreme caution is required when diagnosing failure in these areas.

---

---

## Electrical Cables



### Warning

PERSONAL INJURY. Use only the main power cable supplied with the printer. The end of this cable must have an approved, three-pole, main plug that has a protective ground conductor.

The electrical power cables, sockets and plugs must be kept clean and dry.

For pluggable equipment, the socket-outlet must be installed near the equipment and must be easily accessible.

---



### Warning

PERSONAL INJURY. Always inspect the cables for damage, wear, corrosion, and deterioration. Make all grounding/bonding connections void of areas of paint, ink build-up, and corrosion.

---

## Grounding and Bonding



### Warning

PERSONAL INJURY. The printer must be connected to an AC power supply that has a protective ground conductor and must be according to IEC requirements or applicable local regulations.

---



### Warning

PERSONAL INJURY. Do not use the printer if there is any interruption in the protective ground conductor or if the protective ground conductor is disconnected. The failure to follow this warning can cause an electrical shock.

---

 **Warning**

PERSONAL INJURY. Always ground conductive equipment to an earthing electrode or to the building grounding system with approved cables as per NEC standards in order to drain all potential static discharge. For example, a metal service tray to earth ground.

---

 **Warning**

PERSONAL INJURY. A resistance reading from the grounded service tray to the equipment chassis or mounting bracket should be 0 to less than 1 ohm. A resistance check should be made using a safe and reliable ohmmeter and should be done on a frequent basis.

---

 **Warning**

PERSONAL INJURY. The PCBs contain static sensitive devices. A suitably grounded, antistatic wrist strap must be worn when working on or handling PCBs.

---

 **Warning**

PERSONAL INJURY. Always prevent static discharge from occurring. Use proper Grounding and Bonding methods. Only use Videojet approved metallic service trays and ground cables.

---

 **Warning**

PERSONAL INJURY. Always bond conductive equipment together with approved cables to maintain them at the same potential and minimize static discharge. For example, printhead to metal service tray.

---

**Warning**

PERSONAL INJURY. The Optional Wash Station has been *solely* designed for the cleaning of the printhead.

Do not use it for purging or printing operations or for any other purposes.

Always ensure that the jet is stopped and that any hazardous voltages are switched off prior to the commencement of the printhead wash down.

**Caution**

EQUIPMENT DAMAGE. Always empty the service trays frequently. Some inks and cleaning solutions are flammable. Make sure that the waste fluids are disposed according to HAZMAT.

## Fuses

**Warning**

PERSONAL INJURY. To ensure continued protection against fire hazards, replace fuses only with the specified type and rating.

## Fluid Safety Guidelines

This section describes the hazards that may occur while handling ink, make-up fluid, and cleaning solutions, and the safety precautions that a user must take to prevent the hazards.

### Read the Material Safety Data Sheets

Read and understand the *Material Safety Data Sheet (MSDS)* before using any ink, make-up fluid, or cleaning solution. An MSDS exists for each type of ink, make-up fluid, and cleaning solution. For more information, visit [www.videojet.com](http://www.videojet.com) and navigate to *Documentation > Material Safety Data Sheets*.

## Ink and Make-up Fluid

### **Warning**

PERSONAL INJURY. The ink and make-up fluid are irritating to the eyes and respiratory system. To prevent personal injury when handling these substances:

Always wear protective clothing and rubber gloves.

Always wear goggles with side-shields or a face mask. It is also advisable to wear safety glasses when carrying out maintenance.

Apply barrier hand cream before handling ink.

If ink or make-up fluid contaminates the skin, wash immediately with soap water. DO NOT use washdown or solvent to clean ink stains from the skin.

---

### **Warning**

PERSONAL INJURY. The ink and make-up fluid are volatile and highly flammable. They must be stored and handled in accordance with local regulations.

Do not smoke or use a naked flame in the vicinity of these substances.

Immediately after use, remove any tissue or cloth that becomes saturated with these substances. Dispose all such items in accordance with the local regulations.

In the event that any ink or make-up fluid container is not completely empty after use, it should be resealed. Only full bottles are recommended for use when replenishing ink or make-up fluid; partially filled bottles must be disposed in accordance with the local regulations.

---

### **Warning**

PERSONAL INJURY. When setting up the nozzle, direct the ink stream into a beaker or suitable container. To avoid the contamination of the ink, do not re-use any ink collected in this way. Dispose all waste ink in accordance with the local regulations.

---



**Warning**

PERSONAL INJURY. Prolonged breathing of make-up fluid or cleaning fluid vapor may cause drowsiness and/or effects similar to alcoholic intoxication. Use only in open, well-ventilated areas.

## Cleaning Solution

**Warning**

PERSONAL INJURY. The cleaning solution is poisonous if taken internally. Do not drink. Seek medical attention immediately if ingested.

**Warning**

PERSONAL INJURY. The cleaning solution is irritating to the eyes and respiratory system. To prevent personal injury when handling this substance:

Always wear protective rubber gloves and clothing.

Always wear goggles with side-shields or a face mask. It is also advisable to wear safety glasses when carrying out maintenance.

Apply barrier hand cream before handling ink.

If cleaning solution contaminates the skin, rinse off with running water for at least 15 minutes.

**Warning**

PERSONAL INJURY. The cleaning solution is volatile and highly flammable. It must be stored and handled in accordance with local regulations.

Do not smoke or use a naked flame in the vicinity of the cleaning solution.

Immediately after use remove any tissue or cloths that become saturated with cleaning solution. Dispose all such items in accordance with local regulations.

 **Caution**

EQUIPMENT DAMAGE. Ensure that the cleaning solution is compatible with the ink used before carrying out printhead cleaning otherwise the printhead may get damaged.

---

 **Caution**

EQUIPMENT DAMAGE. Any cleaning solutions containing either chloride, including hypochlorite bleaches or hydrochloric acid, can cause unacceptable surface pitting and staining. These should not be used in contact with stainless steels. If wire brushes or wire scouring pads are used, these should be made of stainless steel. Make sure that any abrasive media used is free from sources of contamination, especially iron and chlorides.

---

## Compressed Air Safety Guidelines

 **Warning**

PERSONAL INJURY. Airborne particles and substances are a health hazard. Do not use high pressure compressed air for cleaning purposes.

---

## UI Related Safety Guidelines

 **Caution**

DATA SECURITY. To prevent unauthorized access to the software, ensure that **Clear Password** is executed when exiting from a higher level password.

---

**Caution**

RISK OF DATA LOSS. Ensure the correct message name is selected for message deletion as no message selection confirmation prompt is given. All messages apart from the TEST MESSAGE will be deleted when you select the **Delete All Messages** option.

**Caution**

RISK OF DATA LOSS. The **Delete User Field** option does not ask for confirmation to delete a User Field.

## Other Important Guidelines

**Caution**

EQUIPMENT DAMAGE. After a Quick Stop, the machine should not be left in this state for any length of time as drying ink may make restarting difficult.

**Caution**

EQUIPMENT DAMAGE. The printhead must be completely dry before attempting to start the printer otherwise the EHT will trip.

**Warning**

PERSONAL INJURY. If the battery is replaced by an incorrect type, it will lead to an explosion. Always dispose off the used batteries according to the instructions and local regulations.



### **Warning**

PERSONAL INJURY. In a fault condition, heater can reach 70 °C. Do not touch the plate on which the heater is mounted. The failure to follow this warning can cause personal injury.

---

## Videojet 1220/1520 Printer

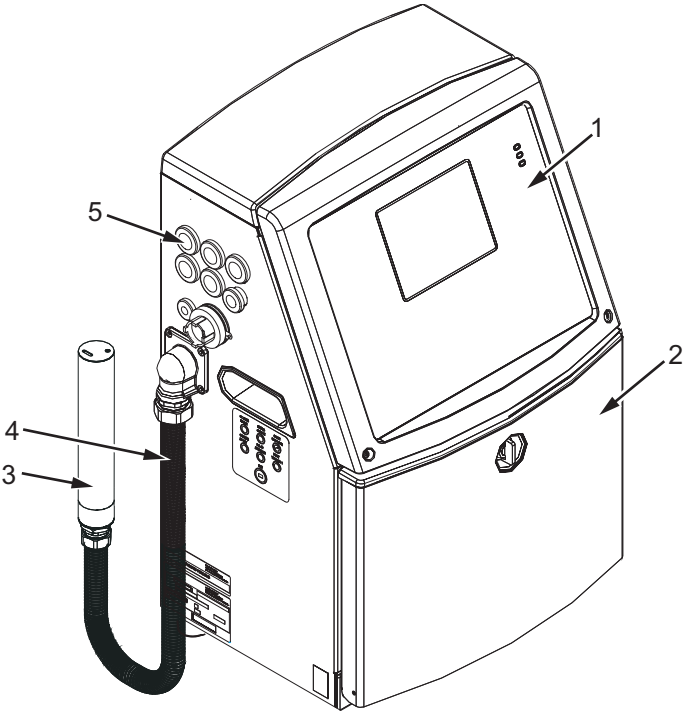

- 1. Control Panel
- 2. Ink Compartment
- 3. Printhead
- 4. Umbilical
- 5. Connector Panel
- 6. Electronics Compartment\*
- 7. Main Power Switch\*
- 8. Back Filter\*

\*The components are not shown in the picture.

Figure 3-1: Main Parts of the Printer (Videojet 1220)

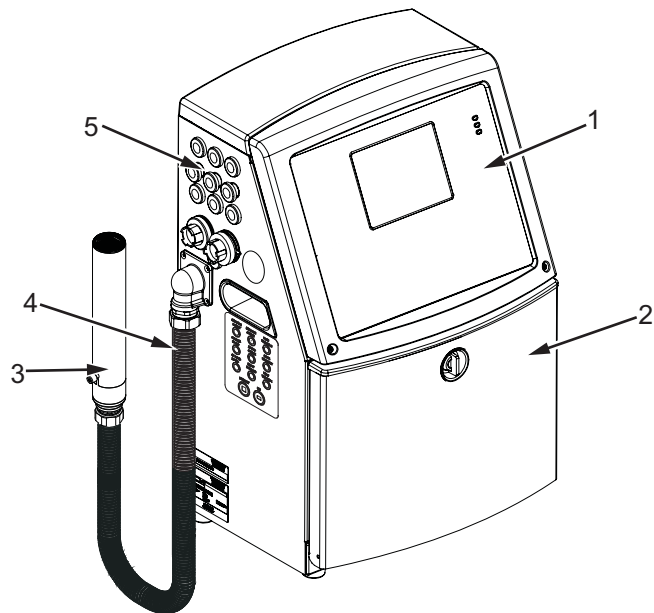

- |                    |                             |
|--------------------|-----------------------------|
| 1. Control Panel   | 5. Connector Panel          |
| 2. Ink Compartment | 6. Electronics Compartment* |
| 3. Printhead       | 7. Main Power Switch*       |
| 4. Umbilical       | 8. Back Filter*             |

\*The components are not shown in the picture.

Figure 3-2: Main Parts of the Printer (Videojet 1520)

## Control Panel

You can use the control panel (Figure 3-3) to do the following tasks:

- Start and stop the printer
- Create, edit, copy and delete the print messages
- Select a message to print
- Monitor the status of the printer
- Configure and control the printer functions

**Note:** You can set the password protection for some functions to prevent any access that is not authorised.



- |                    |                  |
|--------------------|------------------|
| 1. Status LEDs     | 5. Display       |
| 2. Arrow Keys      | 6. Contrast Key  |
| 3. Keypad          | 7. Function Keys |
| 4. Information Key |                  |

Figure 3-3: Control Panel

**Note:** Language specific keypads are provided with the language kits.

### Status LEDs

The light emitting diodes (LEDs) (item 1, Figure 3-3) indicate the system status.

## Arrow Keys

The arrow keys (item 2) allow the operator to navigate through the software menus.

## Keypad

The keypad (item 3) is 72 key, QWERTY, membrane type with tactile response keys. The solvents that you use for printing and maintenance do not damage the keypad.

## Display

The Quarter Video Graphics Array (QVGA) Liquid Crystal Display (LCD) (item 5) has a resolution of 320 x 240 pixels. The LCD has an LED backlight to help you see in low light conditions.

## Contrast Keys

The contrast keys  (item 6) help the operator to increase or decrease the contrast of the LCD.

## Function Keys

The following four function keys provide the basic printer controls (item 7):



Start or stop the ink jet



Select a message for printing



To enter the password



View and edit the messages

For more information on function keys, refer to “Soft Keys” on page 5-3.



## Display Screen



Figure 3-4: Display Screen

The screen displays the following elements:

- The function key controls.
  - The icons that indicate the printer status and fault conditions and the product counter\*.
- \* When the product counter is enabled, the screen displays the product counter:*
- The name and the content of the message. The content in the display is an accurate representation of what the printer prints on the product (WYSIWYG).
  - The icons that indicate the fluid levels in the ink and make-up fluid cartridges.
  - Ink type. For example: V501 A D.

## Electronics Compartment

The electronics compartment contains the parts shown in Figure 3-6.

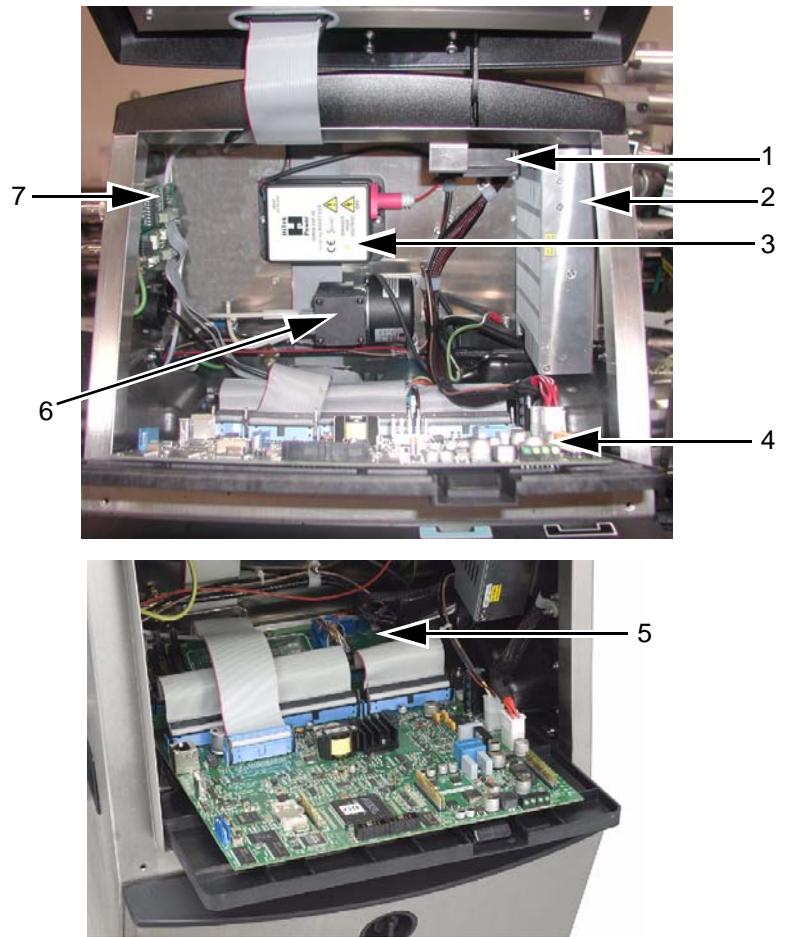

- |                                   |                                  |
|-----------------------------------|----------------------------------|
| 1. Electronics Compartment Fan    | 5. Printer Interface Board (PIB) |
| 2. Power Supply Unit              | 6. Positive Air Pump**           |
| 3. Extra High Tension (EHT) Block | 7. Connector Panel Boards        |
| 4. Control System Board           |                                  |

\*\*Optional on Videojet 1220

Figure 3-5: Electronics Compartment (Videojet 1220)

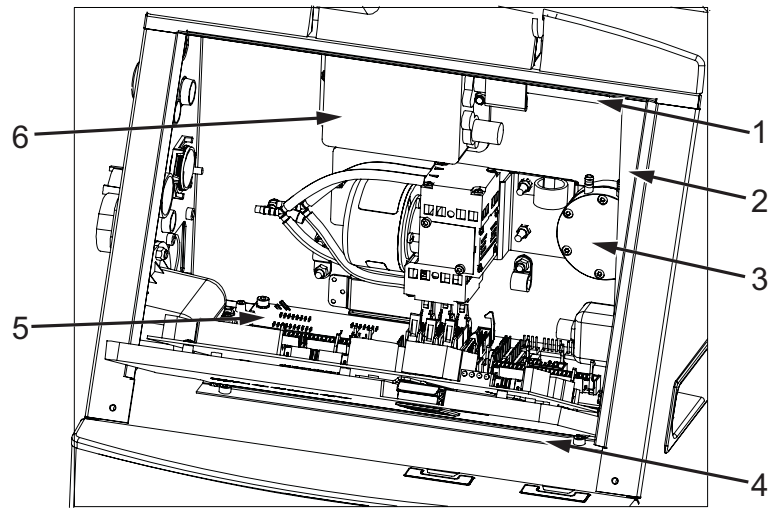

- |                                |                                  |
|--------------------------------|----------------------------------|
| 1. Electronics Compartment Fan | 5. Printer Interface Board (PIB) |
| 2. Power Supply Unit (PSU)     | 6. EHT Module                    |
| 3. Positive Air Pump           | 7. Connector Panel Boards*       |
| 4. Control System Board (CSB)  |                                  |

\* - Component is not shown in the figure

Figure 3-6: Electronics Compartment (Videojet 1520)

**Note:** When a customer orders a Videojet 1220/1520 printer with an air dryer, the positive air pump is removed from the printer. The air dryer supplies positive air to the printhead from an external air source. Air dryers are required when the printer is operated in an environment with elevated humidity or where certain water sensitive inks are used. Please contact Videojet Technologies Inc. Customer Service Department at 800.843.3610 (United States only), or contact the local Videojet Technologies Inc. representative for more information.

## Ink Compartment

The ink compartment of the printer contains the ink core module, and the smart ink and make-up fluid cartridges. The cooling fan cools the ink compartment and a filter does not allow the dust into the ink compartment.

### Ink Core Module

The ink core module maintains the pressure and viscosity of the ink in the printer, and contains the following parts:

- Ink Module
- Ink Pump

**Note:** The ink core module comes as a single unit. You cannot remove or replace any part inside the ink core module except the ink pump.

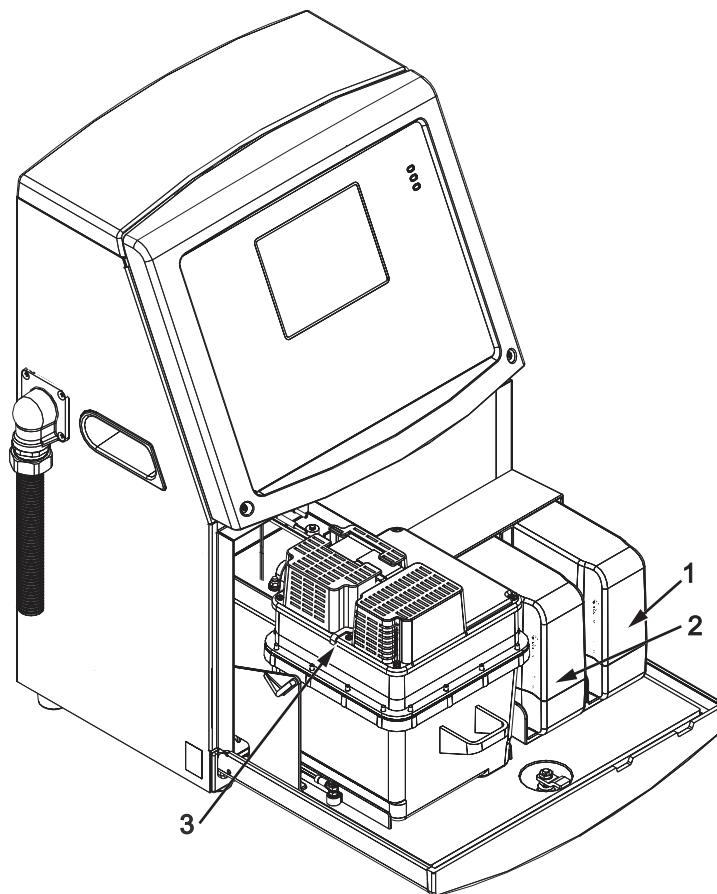

- |                            |                         |
|----------------------------|-------------------------|
| 1. Ink Cartridge           | 4. Ink Compartment Fan* |
| 2. Make-up fluid Cartridge | 5. Gutter Pump*         |
| 3. Ink Core Module         |                         |

\*The components are not shown in the picture.

Figure 3-7: Ink Compartment

## Smart Cartridge

*Note:* Refer to “Replace Smart Cartridges” on page 6-4 to replace the cartridges.

The smart cartridges use the smart chip technology to ensure the proper and in shelf-life ink and make-up fluids are used.

## Ink Compartment Fan

The ink compartment fan cools the ink module and the ink pump.

## Printhead and Umbilical

The printhead uses the ink supplied by the ink core module to print the text and graphic characters on a product. The control signals and ink are sent to the printhead through the umbilical.

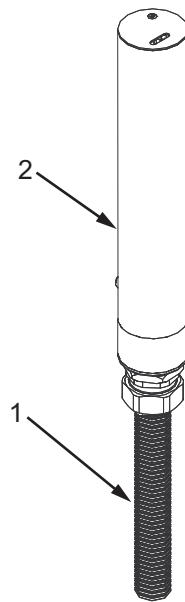

- 1. Umbilical
- 2. Printhead

*Figure 3-8: Printhead and Umbilical (Videojet 1220)*



- 1. Umbilical
- 2. Printhead

Figure 3-9: Printhead and Umbilical (Videojet 1520)

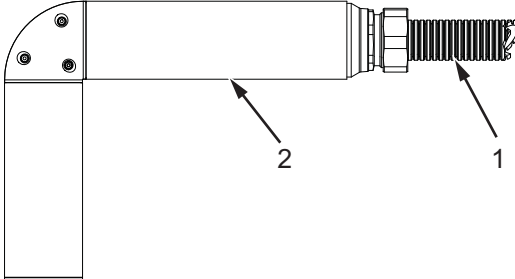

90° Printhead

- 1. Umbilical
- 2. Printhead

Figure 3-10: Printhead and Umbilical (Videojet 1220)

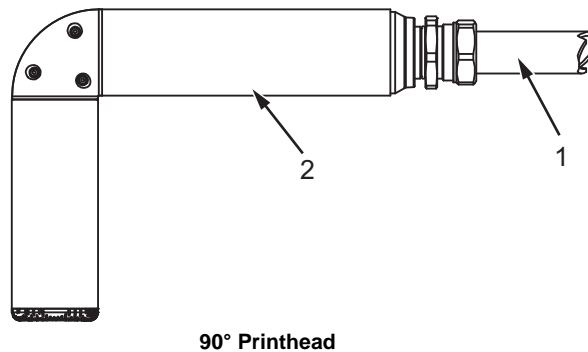

- 1. Umbilical
- 2. Printhead

Figure 3-11: Printhead and Umbilical (Videojet 1520)

## Connector Panel

The connector panel is on the left side of the printer (item 5, Figure 3-1 on page 3-1). The panel contains the connectors shown in Figure 3-12 on page 3-12.

*Note:* The number of connectors provided depends on the model you select.

Table 3-1 provides the connectors for the printer.

Connector Type	PCB	Standard	Optional
Print Trigger 1	PCB 0	Videojet 1220	-
Print Trigger 1	PCB 1	Videojet 1520	Videojet 1220
COMMS RS232	PCB 2	Videojet 1520	Videojet 1220
COMMS RS485	PCB 1	Videojet 1520	Videojet 1220
Shaft Encoder	PCB 2	Videojet 1520	Videojet 1220
Relay Switches	PCB 1	Videojet 1520	Videojet 1220
Status Output (Lampstack)	PCB 2	Videojet 1520	Videojet 1220
USB	-	Videojet 1220/1520	-
Message A Input	PCB 3	-	Videojet 1520
Print Trigger 2	PCB 3	-	Videojet 1520
Message B Input	PCB 3	-	Videojet 1520

Table 3-1: Connector Panel Ports

Connector Type	PCB	Standard	Optional
Ethernet	-	Videojet 1520	-

Table 3-1: Connector Panel Ports (Continued)

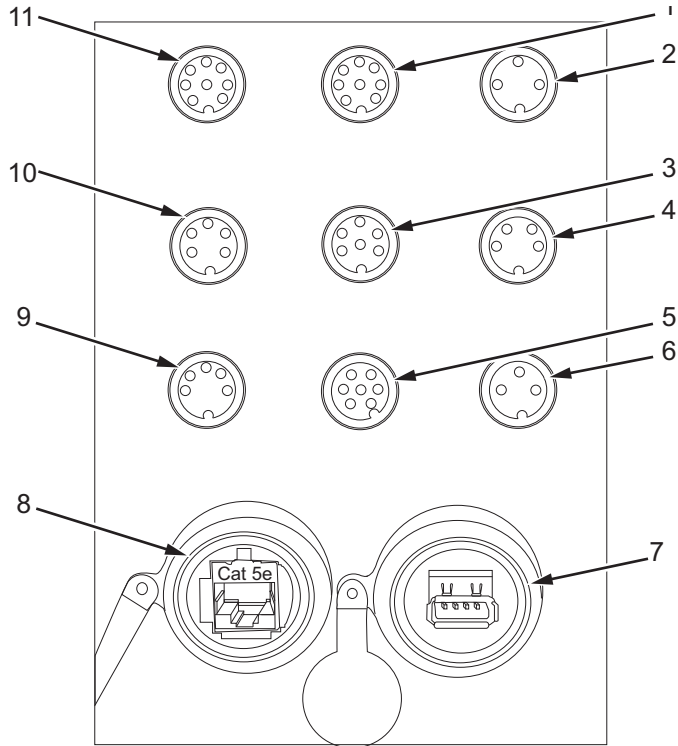

- |                                    |                     |
|------------------------------------|---------------------|
| 1. Message A Input                 | 7. USB              |
| 2. Print Trigger 2 (Reverse Print) | 8. Ethernet         |
| 3. Status Output (Lampstack)       | 9. COMMS RS485      |
| 4. Shaft Encoder                   | 10. COMMS RS232     |
| 5. Relay Switches                  | 11. Message B Input |
| 6. Print Trigger 1                 |                     |

Figure 3-12: Connector Panel

## Pinout Information

Connector	Pinout
Print Trigger 2 (Reverse Print)	DIN 3 Pin
Status Output (Lampstack)	DIN 6 Pin
Shaft Encoder	DIN 4 Pin
Relay Switches	DIN 7 Pin

Table 3-2: Connector Pinout Information



Connector	Pinout
Print Trigger 1	DIN 3 Pin
USB	-
Ethernet	-
COMMS RS485 (180° Pin Position)	DIN 5 Pin
COMMS RS232	DIN 5 Pin
Message B Input	DIN 8 Pin
Message A Input	DIN 8 Pin

Table 3-2: Connector Pinout Information

## Main Power Switch

The main power switch (item 1, Figure 3-13) is a green push button to turn the printer on and off. You can find the main power switch on the right side of the printer.

*Note:* The handles (item 2) are provided for easy movement of the unit.

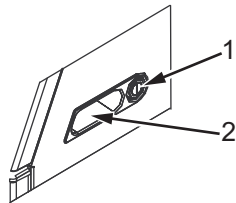

- 1. Main Power Switch
- 2. Handles

Figure 3-13: Main Power Switch

## Back Filter

The ink compartment fan draws the air from the outside atmosphere to keep the ink compartment cool. The back filter removes the dust from the air that goes inside the ink compartment. The IP55 back filter is standard for Videojet 1220/1520. The IP65 back filter is not available for Videojet 1220 and is optional for Videojet 1520.

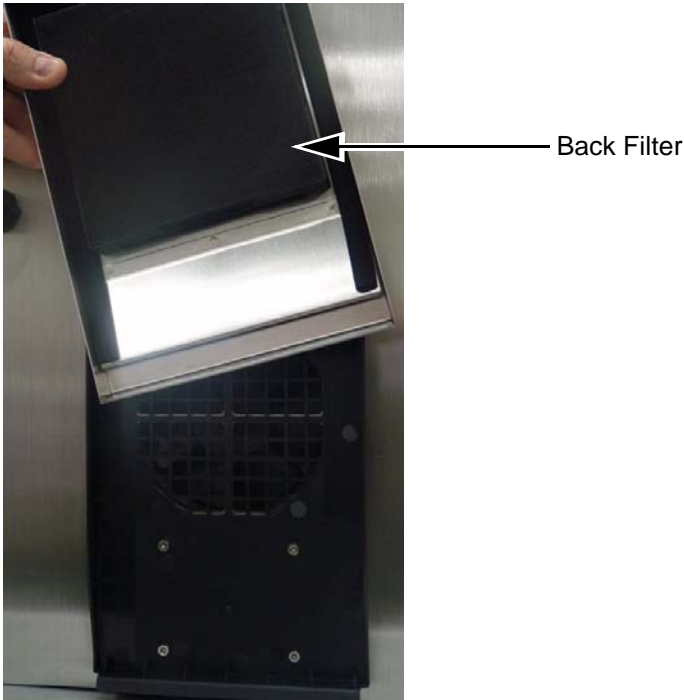

Figure 3-14: Back Filter (IP55 Version) - Videojet 1220

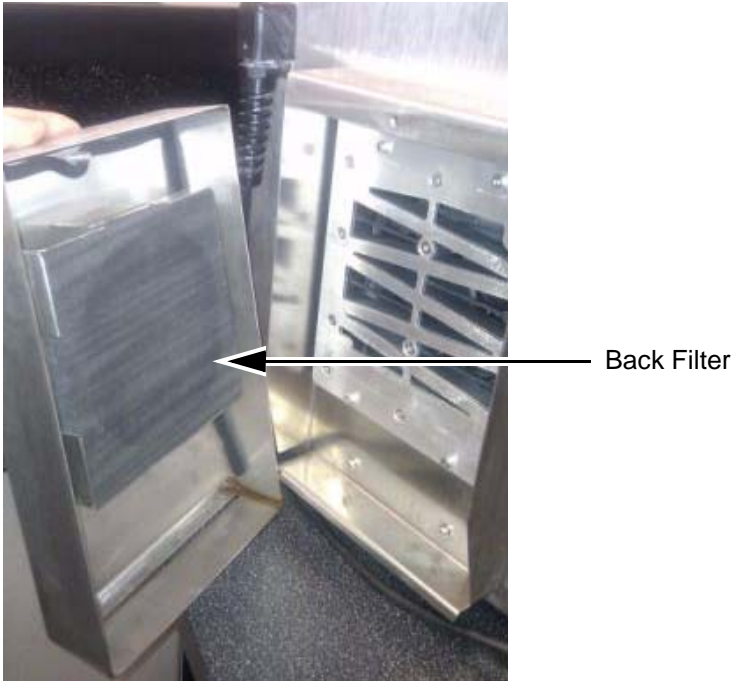

Figure 3-15: Back Filter (IP55 Version) - Videojet 1520

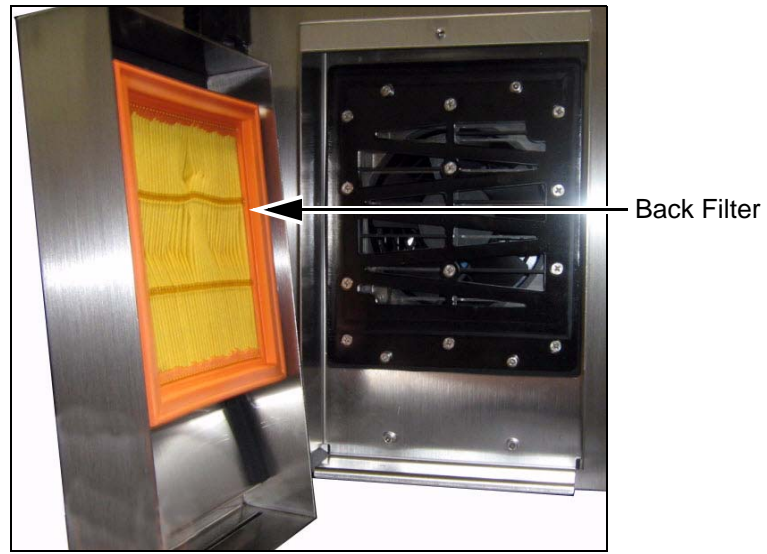

Figure 3-16: Back Filter (IP65 Version) - Videojet 1520

## Introduction

This chapter provides the procedures to do the following tasks:

- Turn on the printer
- Clean start and stop the printer
- Turn off the printer
- Create a message
- Print the messages
- System menu
- Calibrate menu
- Data logging menu
- Product counter
- Run hours
- Configure serial port
- Configure ethernet
- High speed remote data transfer
- Enter service information
- Printer configuration
- Create custom font

## How to Turn on the Printer

Do the following tasks to turn on the printer:

- 1 Do the visual inspection.
- 2 Make sure that the electrical supply for the printer is available.
- 3 Press the main power switch to turn on the printer.

## How to Clean Start and Stop the Printer

The default procedures to start and stop the printer are the Clean Start and the Clean Stop.

*Note: If the Clean Start or the Clean Stop are not available, the printer requires a Quick Start or Quick Stop. (press Ctrl+ F1 for Quick Start and Quick Stop) The printer cannot provide the Clean Start and the Clean Stop options if the make-up fluid is empty or if the ink core level is high. Make sure that the make-up fluid is not empty or the ink core level is not high.*



### Caution

EQUIPMENT DAMAGE. Do not perform the Clean Start or the Clean Stop many times. The failure to follow this caution can cause high use of flush and dilution of the ink. The diluted ink decreases the quality of the print.

---

### How to Clean Start

Press the *F1* key to start the jet start sequence.

The printer turns on the ink and the ink jet starts.

*Note: To stop the ink jet, press the F1 key.*

### How to Clean Stop

Press the *F1* key. The printer stops the flow of ink.

## How to Set the Passwords

The passwords are set and configured from the *Password* menu in the UI.

The UI has the following access levels:

- The level 0 is the default password level.
- The levels 1 and 2 are password protected. The customer can configure the two levels. The customer can use the two levels to access different menus in the UI. To set the passwords for the two levels, you must access the system at same access level or one level higher.



Figure 4-1: Password Menu

## How to Login for the First Time

Do the following tasks to login for the first time:

- 1 Open the Menu screen. The screen appears in level 0 with basic functions.
- 2 Press *Alt + w*. Select the *Enter Password* (see Figure 4-2) option and press the *Enter* key. Alternatively, press F3 in the Main screen. The *Enter Password* screen appears (see Figure 4-3).



Figure 4-2: Enter Password

- 3 Log in at level 1 (default password = 1111) or level 2 (default password = 2222) password. The current password level changes to selected password level from level 0.



Figure 4-3: Level 0 Password

## How to Set the Passwords for Levels 1 and 2

Do the following tasks to set the passwords for levels 1 and 2:

- 1 Press *Alt + w* and select *Set Password for level 1* or *Set Password for level 2* from the *Password* menu (see Figure 4-4). The *New Password* dialog box appears (see Figure 4-5).

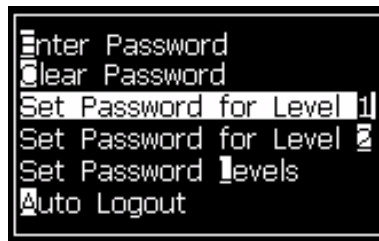

Figure 4-4: Set Password Level

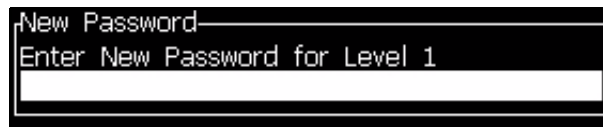

Figure 4-5: New Password

- 2 Enter the new password and press the *Enter* key. A prompt appears where you confirm the password.



Figure 4-6: Confirm Password

- 3 Enter the new password again and press the *Enter* key.

If the confirmation password is different from the first password entered, the *Change Password* dialog box appears (see Figure 4-7).

Press *Esc* key to return to the *New Password* dialog box.

Else, the new password is saved and the Menu screen appears.

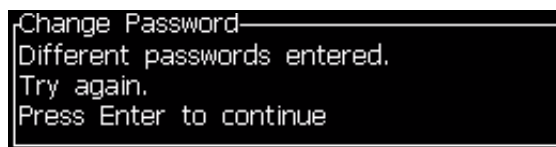

Figure 4-7: Change Password

## How to Set the Password Levels for Menus

Do the following tasks to set the password levels for the menus available in the UI:

- 1 Press *Alt + w* and select *Set Password Levels* (see Figure 4-8) to open the *Change Password Levels* screen (see Figure 4-9 on page 4-5).



Figure 4-8: Set Password Levels

- 2 Select the menu (see Figure 4-9 on page 4-5) that needs a change in the password level access and press the *Enter* key. The *Enter New Password Level* screen appears (see Figure 4-11 on page 4-6).

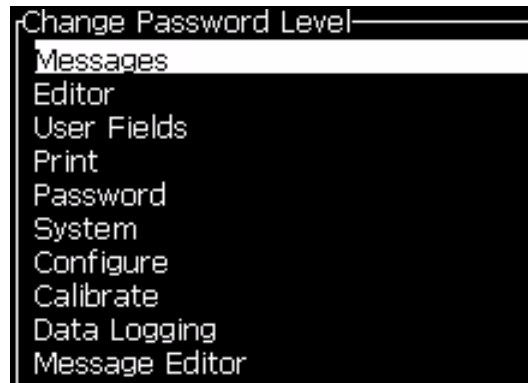

Figure 4-9: Change Password Level

- 3 Change the password levels for the different menus and press the *Enter* key to save the changes.

**Note:** The *Messages* menu is shown here as an example.

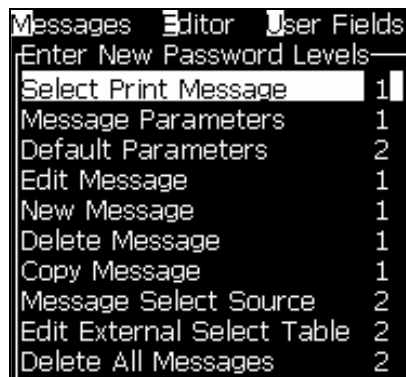

Figure 4-10: Enter New Password Levels



- 4 Press the *Esc* key to go to the menu screen.

## How to Access Other Password Levels

Do the following tasks to access other password levels:

- 1 Press *Alt + w* and select the *Enter Password* option from the *Password* menu. Alternatively, press F3 in the Main screen. The *Enter Password* dialog box appears (see Figure 4-11).



Figure 4-11: Enter Password Dialog Box

- 2 Enter the password for the feature level you must access. The current access level used is shown at the top of the dialog box.

You can use all the menu options that are set at this password level or below that level.

## How to Clear the Password

### Caution

**RISK OF UNAUTHORIZED ACCESS.** To prevent unauthorized access to the software, make sure that you do Clear Password when you exit from a higher level.

Press *Alt + w* and select *Clear Password* (see Figure 4-12) to clear the password for the access level used at this time and return to password level 0.

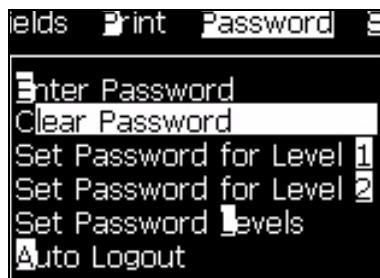

Figure 4-12: Clear Password Option

**Note:** The password is not deleted, but the user access is reset to the lowest privilege level from the current level.

### Auto Logout

If this feature is enabled, the UI prompts for a password at level 0 and all access levels above level 0.

Press *Alt + w*. Select *Auto Logout* (see Figure 4-13 on page 4-7) and press *Enter*. Use the *Right* or *Left* key to select *Yes* or *No*.

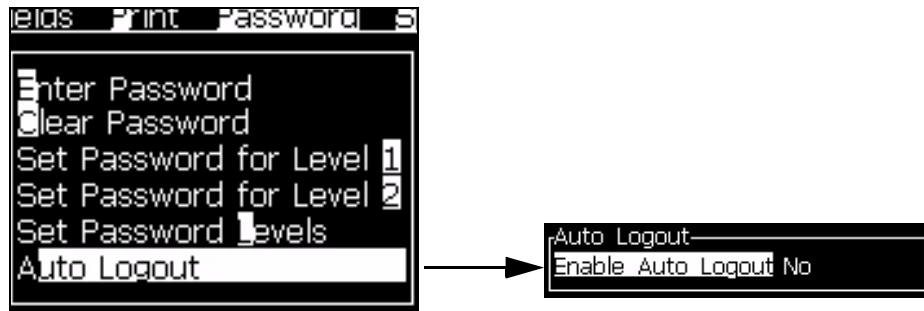

Figure 4-13: Auto Logout Option

## System Menu

The user can perform the start and stop sequences through *System* menu (press *Alt+S*) (see Table 4-1).

<p>Alarms Screen</p>  <p>Current Alarms          EHT calibration required          Ink core service overdue          New Ink Core has a different ink reference.</p>	<p>When the alarm messages appear on the screen, the printer stops the printing. The shortcut key ALT + S and 'A' allows the user to access the alarms screen.</p> <p><b>Note:</b> Diagnostics screens can be accessed and scrolled through, by pressing <i>i</i> key on the keypad.</p>
<p>Warnings Screen</p>  <p>Current Warnings          Charge DAC not zeroed          Head temp too low          Ink cartridge expired          Ink insertions exceeded          Makeup cartridge expired          Makeup insertions exceeded          Viscosity not calibrated</p>	<p>The printer continues the printing after the warning messages appear on the screen. The shortcut key ALT + S and 'W' allows the user to access the warnings screen.</p> <p><b>Note:</b> Diagnostics screens can be accessed and scrolled through, by pressing <i>i</i> key on the keypad.</p>

Table 4-1: System Menu

<p>States Screen</p>  <p>The screenshot shows a black terminal window with white text. The text reads 'Current States' on the first line and 'Config files read' on the second line. The window has a thin white border.</p>	
---------------------------------------------------------------------------------------------------------------------------------------------------------------------------------------------------------------------------------------------------------------------------------------------------------------	--

*Table 4-1: System Menu*

## Calibrate Menu

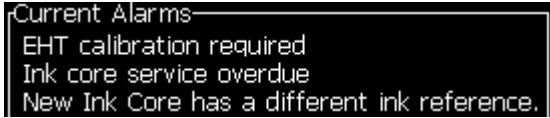
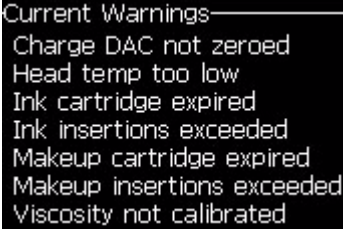
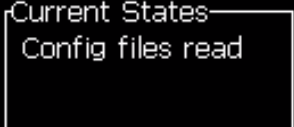
The *Calibrate* menu (press *Alt + L*) (see Table 4-2 on page 4-9) includes the controls to setup and calibrate the printer. Refer to the service manual for more information. The *Diagnostics* screens are available from this menu at password Level 0 and above.

<p><i>Diagnostics Screens One, Two and Three</i></p>	<p>Opens the Diagnostic screen and it allows the user to scroll through the diagnostic screens.(use shortcut keys Alt+L and 1, 2 or 3 to access the diagnostic screens). This screen shows the current value of different parameters to help you find the faults. These diagnostics screens are available (default) from this menu at password level 0 and above.</p> <div style="background-color: black; color: white; padding: 5px; margin-bottom: 5px;"> <p>Diagnostics Screen One</p> <p>Target Pressure 0.000 (0.000)</p> <p>Actual Pressure 0.000</p> <p>Velocity Set Point 22.500</p> <p>Actual Velocity 0.000</p> <p>Head Temperature 0.000 (24.200)</p> <p>Drop frequency 80.000</p> <p>Modulation Voltage 0.000 (0)</p> <p>Printing Phase 0</p> <p>Phasing Threshold 200 (200)</p> <p>Phase Profile 0000000000000000</p> </div> <div style="background-color: black; color: white; padding: 5px; margin-bottom: 5px;"> <p>Diagnostics Screen Two</p> <p>Ink Temperature 0.000</p> <p>Cabinet Temperature -4</p> <p>Pump rpm 0</p> <p>Makeup Vacuum 0</p> <p>Heater Power 100.000</p> <p>Gutter Detect Status in gutter</p> <p>Ink Core Level Empty</p> <p>EHT Voltage 5404.000</p> <p>% EHT Trip 0</p> <p>Traffic light GreenAmber</p> </div> <div style="background-color: black; color: white; padding: 5px;"> <p>Diagnostics Screen Three</p> <p>Ink Core Life 65512</p> <p>Core Hours Remaining 9024</p> <p>Software Version 1.0.339_W</p> <p>Firmware Version 255.255.255</p> <p>Charge Table Version 0.1.1</p> <p>Gutter Pump is present Yes</p> </div> <p>Press <i>Esc</i> key to return to the Menu screen. <b>Note:</b> <i>Diagnostics screens can be accessed and scrolled through, by pressing i key on the keypad.</i></p>
------------------------------------------------------	-----------------------------------------------------------------------------------------------------------------------------------------------------------------------------------------------------------------------------------------------------------------------------------------------------------------------------------------------------------------------------------------------------------------------------------------------------------------------------------------------------------------------------------------------------------------------------------------------------------------------------------------------------------------------------------------------------------------------------------------------------------------------------------------------------------------------------------------------------------------------------------------------------------------------------------------------------------------------------------------------------------------------------------------------------------------------------------------------------------------------------------------------------------------------------------------------------------------------------------------------------------------------------------------------------------------------------------------------------------------------------------------------------------------------------------------------------------------------------------------------------------------------------------------------------------------------------------------------------------------------------------------------------------------------------------------------------------------------------------------------------------

Table 4-2: Calibration Menu

## Data Logging Menu

The *Data Logging* menu (press *Alt + D*) (see Figure 4-14) gives you access to the printer operation data and allows remote access to the data.



Figure 4-14: Data Logging Menu

### How to View Version Information

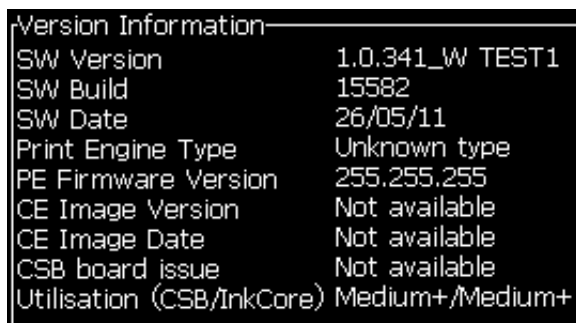

Figure 4-15: Version Information

The *Version Information* (see Figure 4-15) gives the information on the following:

- Version of the software
- The date that the software was created
- Type of printhead engine
- Version of the printhead engine firmware
- CE image version
- CE image date
- CSB board issue
- Utilisation level (Medium+)

## Product Counter

The product counter shows the total number of products that the printer has detected. All detected products are counted here including the products on which the printer has not printed a message.

### How to Reset the Product Counter

Do the following to reset the product counter:

*Note: If you reset the product counter then you cannot undo the operation.*

- 1 Open the *Data Logging* menu (press *Alt + D*).
- 2 Select the *Product Counter* option from the *Data Logging* menu with the arrow key.
- 3 Press the *Enter* key to open the product counter dialog box (see Figure 4-16).

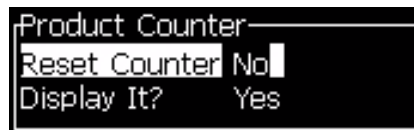

Figure 4-16: Product Counter Dialog Box

- 4 Set the *Reset Counter* field to “Yes” with the *Left* and *Right* arrow keys.
- 5 Press the *Enter* key to reset the product counter and exit the Product Counter dialog box.

### How to Hide the Product Counter

Do the following to hide the product counter:

- 1 Set the *Display it?* field to “No” with the *Left* and *Right* arrow keys.
- 2 Press the *Enter* key to hide the product counter and exit the Product Counter dialog box.

# Run Hours

## How to View Run Hours

To see the number of hours that the printer and ink pump have run:

- 1 Select *View Ink Core Smart Chip Data* from *Calibrate* menu (Figure 4-17).

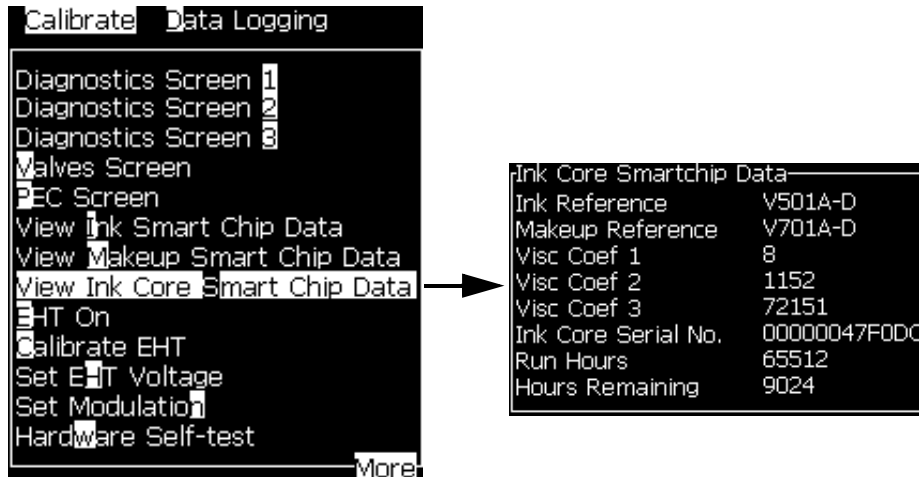

Figure 4-17: View Ink Core Smart Chip Data

- 2 Press any key to close the Run Hours dialog box and return to the Menu screen.

## How to Reset Run Hours

The running hours must be reset only under special conditions like the ink pump replacement and trained service personnel only must perform this operation.

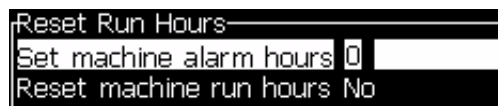

Figure 4-18: Reset Run Hours

## How to Configure the Serial Port

The RS-232 and RS-485 serial communication ports are optional features for Videojet 1220 printer and standard for Videojet 1520 printer. For more information, contact the Videojet distributor or subsidiary.

You can prepare the printer communication ports for the transmission of data logging information between the port and a remote device.

- 1 Open the *Configure* menu (press *Alt + C*).

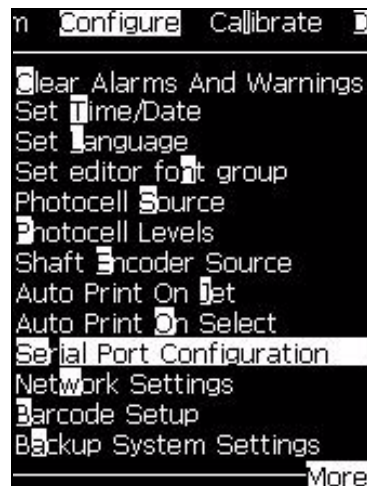

Figure 4-19: Configure Menu

- 2 Select *Serial Port Configuration* option, and press the *Enter* key. The *Configure Serial Ports* dialog box appears (see Figure 4-20).

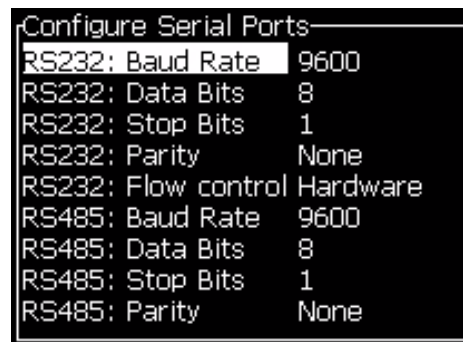

Figure 4-20: Configure Serial Ports Dialog Box

- 3 You can configure the following settings:

Baud Rate	Sets the baud rate for transmission to remote devices
Data Bits	Sets the number of bits used in a data word



Stop bits	Sets the number of stop bits used in a data word
Parity	Select Odd parity, Even parity or No parity for error detection within data transmission

- 4 Press the *Enter* key, when you complete the port configuration.

## How to Configure Ethernet Port

Refer to WSI/ESI Communications Protocol addendum for more information.

## How to Enter Service Information

You can record the service information on the printer.

- 1 Open *Data Logging* menu (press *Alt+D*).



Figure 4-21: Enter Service Information

- 2 Select the *Enter Service Information* option and press the *Enter* key. The *Enter Service Information* dialog box appears (see Figure 4-22).

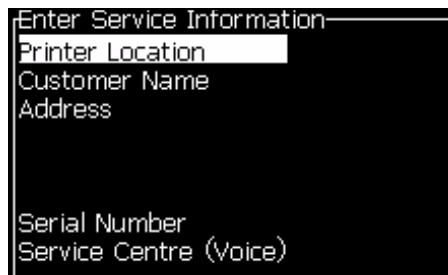

Figure 4-22: Enter Service Information Dialog Box

- 3 Enter the following information in the fields:

Field	Entry
Printer Location	A correct name of location (For example, factory name and machine number).
Customer Name	The name of your company.
Address	Complete postal address of the printer location.
Serial Number	Enter the serial number of the printer.
Service Centre (Voice)	The full telephone number of your local Videojet service centre.

- 4 Press the *Enter* key after you enter the required information.

## How to Create a Message

Refer to “To Create a Message” on page 5-18 for more information.

## Printer Configuration

The printer is configured through the *Print* menu (see Figure 4-23). Press *Alt+P* to open the *Print* menu.



Figure 4-23: *Print* Menu

### Print Enable

Select the *Print Enable* option from the *Print* menu. The *Print Control* menu (see Figure 4-24) appears. Or, press ALT+F1 to start the printing.

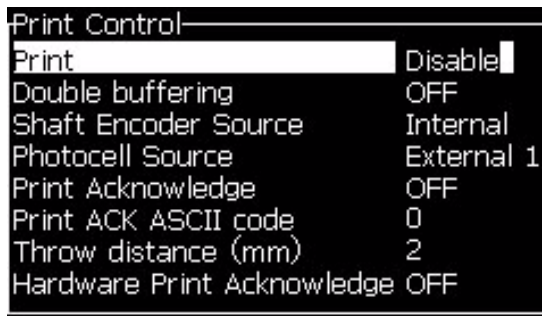

Figure 4-24: Print Control Menu

Table 4-3 describes the options in the *Print Control* menu.

Print	Enable or Disable the printing.	
Double Buffering	The double buffering setting is ON by default. Enable double buffering to print without product delay. Disable double buffering if an external host controls the printing to prevent print delay. Disable this feature during the following modes: Special Print mode, External Message Select and Auto Encoder.	
Shaft Encoder Source	Set the shaft encoder to Internal option for a fixed line speed. Set to External option for use with a compatible shaft encoder where the line speed is variable. <b>Note:</b> <i>If external shaft encoder is selected, the user has to also enter the encoder type (non-quadrature, A then B, or B then A).</i> Set to Auto Encoder for use when speed of the product changes, because the product slips on the conveyor.	
Photocell Source	The print is activated from the source External 1 (standard-connection option), or External 2. <b>Note:</b> <i>An option of "None" is also available in the Photocell Source field.</i>	
Print Acknowledge	Sends a signal to an external control system (normally through the connector COMM1). There are four options.	
	1. Off	The print acknowledge signal is not sent.
	2. After Compile	After the update of any dynamic information like Clock Codes or counter information in the message is printed, the print acknowledge character is sent.

Table 4-3: Print Control Menu

Print ACK ASCII code	Sets the ASCII character code (0 to 255) sent to the control system.
Throw distance	You must enter the distance that is set between the printhead and the product.

Table 4-3: Print Control Menu (Continued)

## Manual Print Option

Select *Manual Print* (see Figure 4-23 on page 4-15) from the *Print* menu if you do not require to start the printing from an external source. When you give the print command, the printer prints one copy of the message.

## How to Use Continuous Print Option

If you enable the *Continuous Print* (see Figure 4-23 on page 4-15) mode, the message is printed repeatedly. The message is printed if only the input of product detect is enabled. When you must print the messages at correct and regular intervals of time on continuous products, this option is useful.

- 1 Select *Continuous Print* from the *Print Menu*. The *Continuous Print* dialog box appears (see Figure 4-25).
- 2 Select *PEC Triggered*. This allows you to see the rising or falling edge on the photocell to start the print.

**Note:** If you enable the *PEC Triggered* option, the printer must get a leading or trailing edge (of the product) signal from the photocell to start the print.

- 3 Or, select *PEC Gated*. This allows you to see a steady signal (i.e. substrate) to keep printing.

**Note:** If you enable the *PEC Gated*, the printer must get a continuous signal to continue the printing.

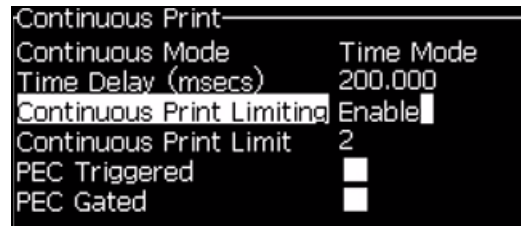

Figure 4-25: Continuous Print Dialog Box

- 4 Set the *SE Mode* delay to use external shaft encoder pulses to set the distance between the start of each print.

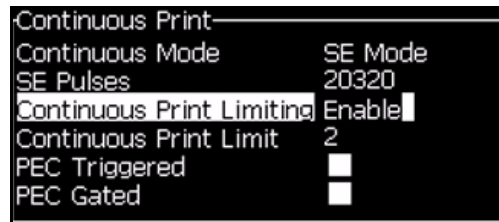

Figure 4-26: SE Mode

- 5 If there is no external shaft encoder, set *Time Mode* delay to use the pulses internally created to set the distance between each print.

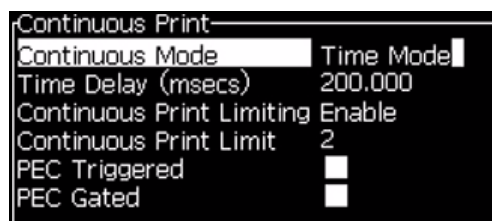

Figure 4-27: Time Mode

- 6 Set the required delay for the selected mode in the range 1 to 10,000.
- 7 Set *Distance Mode* delay to use a user defined distance interval to set the gap between the start of each print.

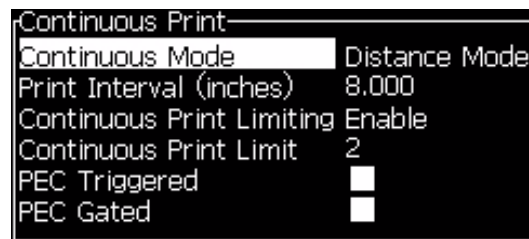

Figure 4-28: Distance Mode

## DIN Print

DIN printing inverts and reverses alternate prints, so that the message can be read from any direction. When printing on cables, this method is used.

## How to Print Messages

You must select a message before you start the printing process.

## How to Select a Message

The Menu screen displays the message that is ready for printing in a box at the bottom of the screen. The name of the message is seen at the top of the box and a preview of the message in the box.

Do the following tasks to select a message:

- 1 Open the *Messages* menu and select the *Select Print Message* option. The *Select Message to Print* dialog box appears.

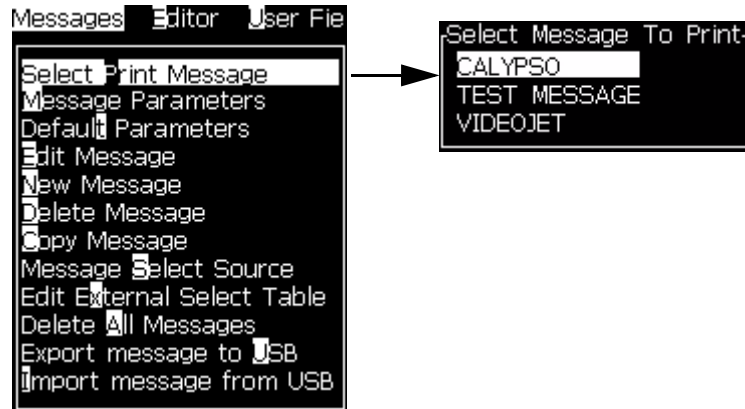

Figure 4-29: Select Print Message

- 2 Press the *Up arrow* key or the *Down arrow* key to highlight the required message. The highlighted message is shown in the **WYSIWYG** part of the display.

**Note:** You can enter the name of the message that you selected to print. The selector bar automatically highlights the required message.

- 3 Press the *Enter* key to select the message for printing. The selected message appears in the **WYSIWYG** of the display.

## How to Start the Printing

The default sequence is Clean Start.

**Note:** You can select the option of *Quick Start* to activate the inkjet. The service technicians use this feature. Refer to the service manual for more information.

- 1 Press the *F1* key to start the jet start sequence.

During the sequence, the jet running icon  flashes on the display. The sequence takes approximately one minute. When the sequence is completed, the icon is turned on continuously.

- 2 To start the printing process, the following operations are required:

- The print must be enabled (access *Print > Print Enable*. The *Print Control* menu appears. Select *Enable* (Quick Key: *ALT + F1*).
- The product sensor must send a trigger signal.
- It may be necessary to adjust message parameters.
- The photocell level may need to be changed (access *Configure > Photocell Levels*).

**Note:** *When the print is enabled, the green LED on the keypad is turned on continuously.*

### Monitor the Printing

When the printer is in the operation, use the following to monitor the status:

- The status icons on the display
- The LEDs on the keypad
- The stack light (optional)

### How to Stop the Printing

Disable the print to stop the printing (access *Print > Print Enable*. The *Print Control* menu appears. Select *Disable* (Quick Key: *ALT + F1*).

You can use the Clean Stop or Quick Stop sequences to stop the jet along with stopping the printing. The default sequence is Clean Stop. The Quick Stop sequence is used by service technicians. Refer to the service manual for more information.

Press the *F1* key to start the jet stop sequence.

During this sequence, the jet stop icon  flashes on the display. The sequence requires one minute to complete. When the sequence is complete, the icon is turned on continuously.

The printing automatically stops after the jet stop sequence is complete.

**Note:** *Do not turn off the printer until the flushing cycle is complete.*

## How to Install and Print Custom Fonts

This procedure shows you how to install custom font and print messages using the custom font.

- Custom Font height must match with the height of the standard font available in the printer. Following are the list of the available font height.

- 5-high
- 7-high
- 9-high
- 12-high
- 16-high
- 24-high
- 34-high
- Custom font file must be in \*.abf2 format.
- The naming convention of the font must be in xxhigh\_custom.abf2. xx represents the height of the font. (Ex: A 16-high custom font file must be named as 16high\_custom.abf2).

### Installation

Do the following tasks to install a custom font:

- 1 Copy the custom font you wish to install to the root of a USB Flash Drive.
- 2 Insert the USB Flash Drive in the USB socket on the side of the printer.
- 3 Press CTRL + F4 key to list files on the USB Drive.
- 4 Select the font file to install.
- 5 Press the *Enter* key. The following message appears in the display screen to confirm the update.

```

Confirm
Please confirm the update
Enter to continue Esc to exit

```

- 6 Press the *Enter* key. The following message appears in the display screen.

**Note:** User must wait for few seconds until the note appears to power cycle the printer.

```

Note
Power-cycle to apply the update
Press any key to continue

```

- 7 Power cycle the printer to apply the updates.

### Create and Print a Message

Do the following tasks to create and print a message using custom font:



- 1 Press the F3 key (while in the Editor Screen) for the *Editor Attributes* screen to appear.

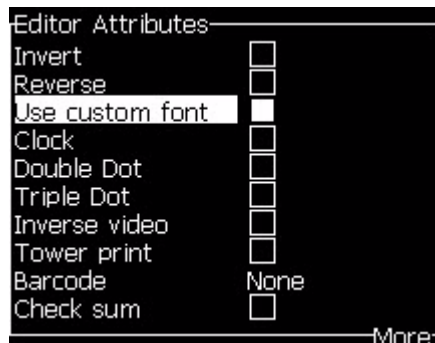

Figure 4-30: Editor Attribute

- 2 Select the *Use custom font* and press the *Enter* key.
- 3 Press the F1 key to select the custom font.

*Note:* Set the font height to match the custom font height.

- 4 Enter the message in the message editor.
- 5 Press Shift + F1 to save and exit.

*Note:* Select message to print, if the message is not loaded.

## Turn off the Printer

### Caution

EQUIPMENT DAMAGE. Turn off the printer after the jet shutdown cycle is complete. The failure to follow this caution can cause additional maintenance.

### Caution

EQUIPMENT DAMAGE. Do not start and stop the printer many times.

When you stop the printer, the printer uses the make-up fluid to flush the system. If you start and stop the printer many times, the printer uses large amount of make-up fluid. The increased use of make up fluid can cause a

Ink Core Level High error and low ink viscosity. To prevent this problem, quick start and stop must be used.

---

Press the main power switch to turn off the printer.

***Note:** It is recommended to start the printer once in every 10 days. If the printer is shutdown for more than 10 days, it is recommended to follow the extended shutdown routine. Refer to “How to Prepare for Long-term Shutdown (Storage) or Transportation” on page 6-2 for the procedure.*

## Introduction

This chapter describes how you can use the user interface (UI) to do the following tasks:

- Create messages
- Edit messages
- Save messages
- Create user fields

The UI contains the following screen:



Figure 5-1: Menu Screen

### Menu Screen

When you login, the first screen that appears is Menu screen. The Menu screen has a row of menus along the top of the screen. The menus give quick and easy access to the different functions of the printer. You can see only five menus in the screen (see Figure 5-1), press the *Left arrow* key or *Right arrow* key to access the other menus.

## To Select the Menus and Items

To select the menus, and the items in the menus, you can use either the arrow keys or the short cut keys.

### Arrow Keys

To select a menu:	<ol style="list-style-type: none"> <li>1. Press the <i>Left arrow</i> key or <i>Right arrow</i> key until the menu is highlighted.</li> <li>2. Press the <i>Enter</i> key.</li> </ol>
To select an item from a menu:	<ol style="list-style-type: none"> <li>1. Press the <i>Up arrow</i> key or the <i>Down arrow</i> key until the required item is highlighted.</li> <li>2. Press the <i>Enter</i> key.</li> </ol>

**Note:** If there are many items on the menu to display on screen, the label **More** appears next to the top or bottom of the menu. For example, refer to Figure 5-2. This label indicates that more menu entries are available above, or below the items that are displayed now. Press the *Up arrow* key or *Down arrow* key to scroll through the items.

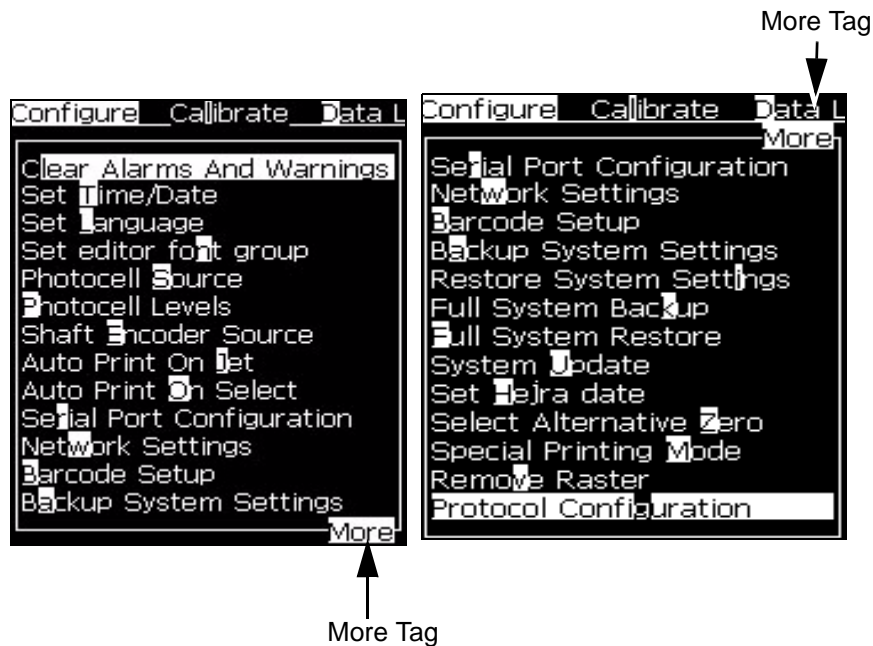

Figure 5-2: The More Tag

## Shortcut Keys

To access the different menus in the main menu, hold the *Alt* key, and press the highlighted character. The menu and the shortcut key are shown in Table 5-1.

Menu	Shortcut Key
Messages	ALT+M
Editor	ALT+E
User Fields	ALT+U
Print	ALT+P
Password	ALT+W
System	ALT+S
Configure	ALT+C
Calibrate	ALT+L
Data Logging	ALT+D
Change Font Height	F1*
Select User Field	F2*
Modify Attributes	F3*
Message Parameters	F4*

Table 5-1: Shortcut Keys

\* - These shortcut keys appear only in Editor menu.

## To Enter the Text, Numbers and Toggle Values

Text	Use the keypad to enter the required text, or special characters.
Numerical values	Use the keys 0 to 9, or press the <i>Right arrow</i> key to increase the value or press the <i>Left arrow</i> key to decrease the value.
Toggle values (for example, on/off)	Press the <i>Left arrow</i> key or <i>Right arrow</i> key.

### Esc Key

To exit from a menu without any change in the settings, press the *Esc* key.

### Soft Keys

The four function keys (*F1* to *F4*) are known as the soft keys. The UI assigns the default functions to these keys in normal conditions. When you hold *Alt* or *Ctrl* key, the UI assigns different functions to the function keys.

The functions that are available for different key combinations are shown in Table 5-2 on page 5-4.

Key	Function
If you hold the alt key	
	
F1	Start Printing (or Stop Print if the printer is in the print mode)
F2	New Message
F3	Message Parameters
F4	Edit User Field

Table 5-2: Soft Keys

Key	Function
If you hold the Ctrl key	
F1	Quick Start (or Quick Stop if the jet is in operation)
F2	Nozzle Flush
F3	Continuous Print
F4	Copy From USB

Table 5-2: Soft Keys (Continued)

## Menu Description

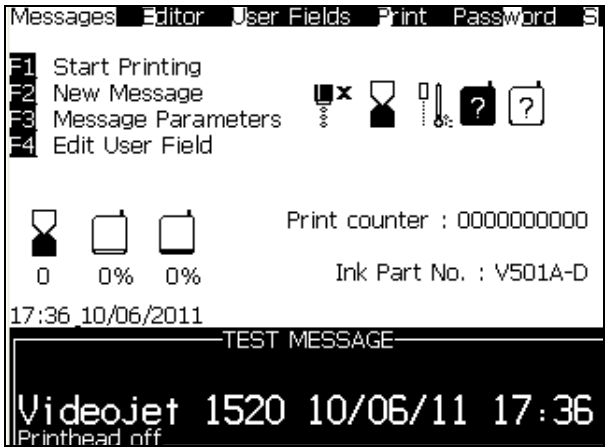
### Messages

Messages Menu	Commands	Function
	Select Print Message	Opens the <i>Select Message To Print</i> dialog box. Select a message to print or edit.
	Message Parameters	Opens the message parameters for the selected message. All parameters can be changed.
	Default parameters	Opens the <i>Default Parameters</i> menu. All the default parameters for new messages can be changed.
	Edit Message	Opens the <i>Select Message to Edit</i> dialog box. The selected message is opened in an edit screen. To save the edited message, go to the <i>Editor</i> menu
	New Message	Opens the <i>New Message</i> dialog box. The system prompts to enter the new message name. The user can enter the new message in the edit screen. To save the new message, go to the <i>Editor</i> menu. The parameters for a new message are set to the default values.
	Delete Message	Opens the <i>Select Message to Delete</i> dialog box. The selected message is deleted. <b>Note:</b> You cannot delete the <i>Test Message</i> and the message selected for printing (shown in the <i>WYSIWYG</i> ).
	Copy Message	Opens the <i>Copy Message</i> dialog box. Enter message names in the <i>From</i> and <i>To</i> fields. If a message exists, and you try to copy the content into that message, the following message appears on the display: <i>"Already exists. Overwrite it?"</i> (answer with Y or N).
Message Select Source* (standard for Videojet 1520 if PCB3 is fitted and not available in Videojet 1220)	Opens the <i>Message Select Source</i> dialog box, with options <i>Internal</i> or <i>External</i> .	

Table 5-3: Messages Menu and Commands



Messages Menu	Commands	Function
	Edit External Select Table* (standard for Videojet 1520 if PCB3 is fitted and not available in Videojet 1220)	Opens the <i>External Message Select</i> menu. Enter the names of the messages to be available to the external source. The external message names can be added, edited and deleted. Press the <i>F2</i> key to select message names from a list of those available.
	Delete All Messages	Deletes all internal messages.
	Export message to USB	You can transfer a single message and all the resources it uses (if you want to take the messages to another printer to print) from the printer to an USB stick.
	Import message from USB	You can transfer a single message and all the resources it uses from the USB stick to the printer.

Table 5-3: Messages Menu and Commands (Continued)

\*Used with Message Select connectors (requires optional PCB 3).

## Editor

The commands in the *Editor* menu are shown only if the Message Editor is open. If the Message Editor is closed, the only option shown in the *Editor* menu is "Only used when in Editor".

**Note:** All Editor commands are available from level 1 and above.

Editor Menu	Commands	Function
	Select Font	<p>Opens the <i>Select Font</i> menu. The selected font is applied to the selected text in the message.</p> <p><b>Note:</b> Press F1 to change font height.</p>
	Insert User Field	<p>Opens the <i>Select user field</i> menu. The contents of the user field are copied into the message at print time.</p> <p>Example: expiry date, shift code.</p> <p><b>Note:</b> Press F2 to select user field.</p>
	Modify Attributes	<p>Opens the <i>Editor Attributes</i> menu. One or more attributes can be set. The set attributes are applied to the selected text in the message. (Attributes are properties that can be applied to individual characters).</p> <p><b>Note:</b> Press F3 to modify attributes.</p>
	In-line Attributes	<p>Opens the <i>Editor Attributes</i> menu. The selected attributes are applied to the text that is about to be entered in the message.</p>
	Copy Text	Copies the selected text to the clipboard.
	Paste Text	Pastes the text from the clipboard at the cursor position.
	Set Keyboard Type	<p>Opens the <i>Select keyboard Type</i> menu. Select the keyboard type to be used for the edit session. Characters from more than one language alphabet can be included in a message.</p>
	Save Message	Saves the message being edited and keeps the editor screen open.

Table 5-4: Editor Menu and Commands

Editor Menu	Commands	Function
	Save and Exit	Saves the message being edited and exits the editor screen.
	Clear Message	Deletes the content in the message and keeps the editor screen open.
	Abandon	Exits the editor screen without saving any changes to the message.

Table 5-4: Editor Menu and Commands

**Note:** Press F4, to select Message Parameters.

## User Fields

**Note:** All User Field commands are available from level 1 and above.

User Fields Menu	Commands	Function
		
Edit user field		<p>Opens the <i>Select user field to edit</i> menu. Options are all the existing user fields.</p> <ul style="list-style-type: none"> <li>• When you select a text field, an individual dialog box for the new user field with the Text and Attribute options opens.</li> <li>• When you select a counter field, a menu with options for the counter parameters opens.</li> <li>• When you select a logo field, the Edit logo screen opens.</li> </ul>
New user field		<p>Adds a new user field to the selected message. Opens the <i>New User Field</i> dialog box with <i>Name</i> and <i>Description</i> fields.</p> <ul style="list-style-type: none"> <li>• When you select a <i>Text</i> description, the <i>New Field</i> dialog box with <i>Text</i> and <i>Attribute</i> fields opens.</li> <li>• When you select a <i>Counter</i> description, the <i>New counter</i> dialog box with fields for the counter parameters opens.</li> <li>• When you select a <i>Logo</i> description, the Edit logo screen opens.</li> <li>•</li> </ul>
Delete user field		Opens <i>Delete User Field</i> menu.
Reset Counter		Opens the <i>Select Counter to Reset</i> menu.
Set Shifts		Opens the <i>shift</i> menu where the duration of each shift can be defined.

Table 5-5: User fields Menu and Commands

## Print

*Note: All Print Menu commands are available from level 2 and above.*

Print Menu	Commands	Function
	Print Enable	Opens the <i>Print Control</i> menu. The <i>Print</i> option can be toggled between <i>Enable</i> and <i>Disable</i> .
	Manual Print	Printing is triggered by an external device in normal conditions (for example, photocell or internal timer). Use manual print to print one copy of the selected message when the print command is given. You can use this feature to check the printer operation while not connected. You must remove the photocell cover to use the manual print.
	Continuous Print	<p>The message is printed again and again without an external trigger.</p> <p>Opens the <i>Continuous print</i> dialog box.</p> <p>You can toggle the Continuous mode between <i>Off</i>, <i>Distance Mode</i>, <i>SE Mode</i> and <i>Time Mode</i>. <i>SE mode delay</i> and <i>Time mode delay</i> can be individually adjusted between 1 and 10000 pulses.</p> <p>Distance Mode uses a user defined distance interval to set the gap between the start of each print.</p> <p>SE mode uses external shaft encoder pulses to set the gap between the start of each print.</p> <p>The <i>Time Mode</i> uses internally generated pulses to set the gap between the start of each print.</p>
	Line Configuration	Line Configuration is a menu that holds all the shaft encoder calibration setting. It also allows the user to set up message units in inches, mm or strokes.

Table 5-6: Print Menu and Commands

## Password

Password Menu	Command	Function
	Enter Password	Opens the <i>Enter Password</i> dialog box, with the current password level. The user has to enter a password to change to a different password level.
	Clear Password	The password is cleared for the current access level and access is returned to password level 0.
	Set Password for level 1	Opens the <i>New Password</i> dialog box. The user has to enter a new password for level 1.
	Set Password for level 2	Opens the <i>New Password</i> dialog box. The user has to enter a new password for level 2.
	Set Password Levels	Opens the <i>Change Password level</i> menu. This has options for the Menu Screen and each of the menus. When an option is selected, a further dialog box appears with options to change the password level for each option available in the menu. The password levels can be set in the range 0 to 2 by the user, where level 0 does not have password protection. Functions with Level 3 access cannot have their password levels changed.
	Auto Logout	<p>If the user does not use the UI for several minutes (no keyboard input), the printer logs out the user and provides access level 0.</p> <p>This feature protects the printer from the unauthorized access.</p>

Table 5-7: Password Menu and Commands

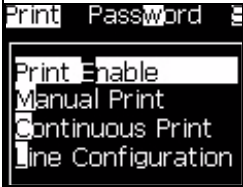
## System

System Menu	Command	Function	
	Alarms Screen	Refer to “System Menu” on page 4-7	
	Warnings Screen		
	States Screen		
	Clean Start Jet	Clean Start Jet	The ink jet is started and Starting the jet is displayed. A flush and bleed sequence is performed to eliminate ink splashing and spray before ink is fed to the nozzle.
	Quick Start Jet	Quick Start Jet	The ink jet is started and the message <i>Starting the jet</i> is displayed. Use Quick Start if the machine has been off for less than half an hour.
	Clean Stop Jet	Clean Stop Jet	The ink jet is stopped, the nozzle and related ink core module pipes are cleaned.
	Quick Stop Jet	Quick Stop Jet	This method starts without a flushing sequence, and uses the ink supply to bleed air from the nozzle.
	Nozzle Flush	Nozzle Flush	The nozzle orifice is cleaned by the application of solvent and a suction action. The flush continues for two minutes unless the <i>F1</i> key is pressed to stop it.
	System Flush Purge	System Flush Purge	The machine is started and the flush pump operated. This function removes air from the flush system during the commissioning or when air has been introduced to the flush system during a fault, etc. Press the <i>Enter</i> key and a dialog box opens: “Are you sure YES-NO”.
	Umbilical Purge	Umbilical Purge	When using <i>Umbilical Purge</i> , the umbilical feed and return tubes must be disconnected from the nozzle feed and return tubes. Loop the umbilical feed and return tubes together and cap the nozzle feed and return tubes. Opens the <i>Umbilical Purge</i> dialog box. Select <i>Enable</i> to start and <i>Disable</i> to stop the umbilical purge.
Empty Ink Core	Empty Ink Core	This function empties the ink from the ink core module and puts the ink in a specially programmed ink cartridge.	

Table 5-8: System Menu and Commands



System Menu	Command	Function
	Fill Ink Core	This function is used to fill an empty ink core module by adding ink from the Ink cartridge. Usually this function is used during commissioning or ink core module replacement.
	Flush Ink Core	Flushing of the ink core will take place. Flush Ink core is performed if the printer is shipped into another location or going for some storage. Follow the screen prompts.
	Copy from USB	This function is used to copy files from a USB stick that is plugged into the machine. It can be used to update software/firmware, add new rasters and fonts. 
	Print Setup Warnings Enable	This function allows the warnings that appear on the screen as icons to be disabled and enabled. 
	Gutter Fault Shutdown Enable	Opens the <i>Machine Control</i> dialog box. You can toggle the Gutter fault between <i>Enable</i> and <i>Disable</i> . 

Table 5-8: System Menu and Commands (Continued)

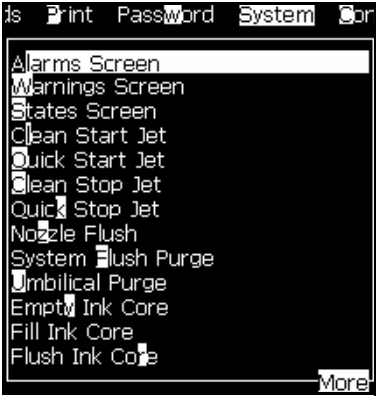
## Configure

Configure Menu	Commands	Function
	Clear Alarms and Warnings	Allows to clear the alarms and warnings that appear on the UI.

Table 5-9: Configure Menu and Commands

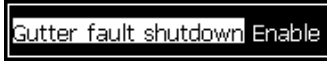

Configure Menu	Commands	Function
	Set Time/Date	<p>Allows the Real Time Clock (RTC) in the printer to be set to the local time and date. Opens the <i>Set time/date</i> menu. The parameters that can be set are: Day, Month, Year, Day number, Hour, Minutes, Seconds.</p> 
	Set Language	<p>Allows the language used for the display to be set. Opens the <i>Select prompt language</i> menu with the language options available (available languages depend on the printer model).</p> 

Table 5-9: Configure Menu and Commands (Continued)





Configure Menu	Commands	Function
	Set Editor Font group	<p>Used to set the editor font group that you require:</p> <ul style="list-style-type: none"> <li>• Chinese</li> <li>• Japanese</li> <li>• International</li> </ul> <p><b>Note:</b> The display language and keyboard language are independent. For example, an operator in China has to print Japanese characters, the display language must be changed to Chinese S or Chinese T. To do this, you must set the keyboard type under the Editor Menu (“To Insert Foreign Language Characters” on page 5-50).</p>   <p>You must set the Editor Font group to Japanese. A power cycle (turn off the printer and turn on the printer) is required.</p>
	Photocell Source	<p>Photocell Source - Selects the photocell source to be used. Opens the <i>Print Control</i> menu. Photocell source can be toggled between <i>External 1</i> and <i>External 2</i>. (NB External 2 requires special software).</p>
	Photocell Levels	<p>To allow the use of both High and Low activating photocells this command enables the photocell trigger level to be set to high or low.</p> 

Table 5-9: Configure Menu and Commands (Continued)

Configure Menu	Commands	Function
	<p>Shaft Encoder Source -The different sources of the shaft encoder signal are: Internal, External and Auto Encoder.(this feature is not available in 1220)</p> <pre>Print Control Print Enable Double buffering ON Shaft Encoder Source Internal Photocell Source External 1 Print Acknowledge OFF Print ACK ASCII code 0 Throw distance (mm) 1 Hardware Print Acknowledge OFF</pre> <pre>Print Control Print Enable Double buffering ON Shaft Encoder Source External Photocell Source Non-quadrature Print Acknowledge OFF Print ACK ASCII code 0 Throw distance (mm) 1 Hardware Print Acknowledge OFF</pre> <pre>Print Control Print Enable Double buffering ON Shaft Encoder Source Auto Encoder Photocell Source External 1 Print Acknowledge OFF Print ACK ASCII code 0 Throw distance (mm) 1 Hardware Print Acknowledge OFF</pre>	
	Auto Print on Jet	<p>You can enable the machine start printing when the ink jet has started.</p> <p><b>Note:</b> A message must be available.</p> <pre>Auto print on jet Enable</pre>
	Auto Print on Select	<p>Enables the machine to be set up so that it will initiate printing as soon as a message has been selected subject to the ink jet having started.</p> <pre>Auto print on select Enable</pre>
	Serial Port Configuration	<p>You can configure the serial port.</p> <pre>Configure Serial Ports RS232: Baud Rate 115200 RS232: Data Bits 8 RS232: Stop Bits 1 RS232: Parity None RS232: Flow control Hardware RS485: Baud Rate 9600 RS485: Data Bits 8 RS485: Stop Bits 1 RS485: Parity None</pre>
	Network Settings	<pre>Network Settings Use DHCP Yes IP address 000.000.000.000 Subnet mask 255.255.255.000 Default gateway 000.000.000.000</pre>

Table 5-9: Configure Menu and Commands (Continued)

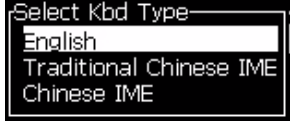



Configure Menu	Commands	Function
	Barcode Setup(1520 only)	<p>Opens the Barcode Bar/Space Ratios menu. Up to four bar widths and four space widths can be set.</p> 
	Backup System Settings	Parameters set during the calibration process are saved to memory, overwriting any previously saved parameters.
	Restore System Settings	Previously saved parameters and settings are read from memory, undoing any recent changes.
	Full System Backup	<p>Backs up all programmable printer data, including job and configuration information, to a USB stick.</p> <p><i>Note: You can perform a full system backup after you have set up the system.</i></p>
	Full System Restore	<p>Restores programmable (you can select from the <i>Restore Options</i> menu) printer information, including job and configuration information, from a USB stick, although the printer prompts the user to select which files to recover.</p>  <p><i>Note: For example, when a CBS has failed, you can run a full system restore to recover the lost settings.</i></p>
	System Update	<p>Updates messages, fonts, rasters on printer. System update allows files to be added to the printer without replacing existing files (.cadd file)</p> <p><b>Note:</b> You can perform a software upgrade to upgrade only the required settings and selected elements. The options are:</p> <ul style="list-style-type: none"> <li>• All</li> <li>• Fonts</li> <li>• Application - software version</li> <li>• Messages - move all the messages</li> <li>• Settings - HV calibration, viscosity</li> <li>• Rasters</li> </ul>
	Set Hejra Date	<p>Sets the date per the Arabic calendar.</p> 

Table 5-9: Configure Menu and Commands (Continued)

Configure Menu	Commands	Function
	Select Alternative Zero	<p>Opens the Select alternative zero dialogue box. Alternative zero symbol can be set to one of several available zero characters.</p> 
	Special Printing Mode	<p>Selects DIN printing and traversing printing.</p> 
	Remove Raster	<p>Removes the raster file from the printer.</p> 
	Protocol Configuration	<p>The WSI setup options are available in this menu.</p> 

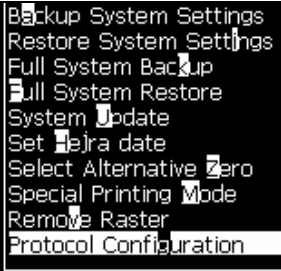
Table 5-9: Configure Menu and Commands (Continued)

## Manage Messages

### To Create a Message

Do the following tasks to create a message:

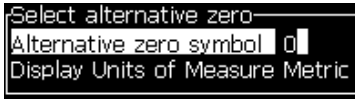
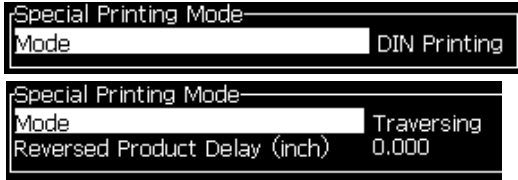
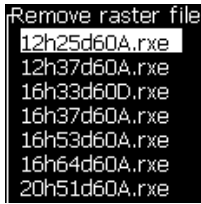
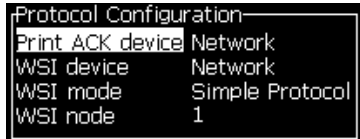
- 1 Press *Alt + M* to open the *Messages* menu

**Note:** You can use quick keys *Alt + F2* to open the messages menu in the menu screen.



Figure 5-3: Messages Menu

- 2 Select *New Message*. The *New Message* dialog box appears (see Figure 5-4).
- 3 Enter a name for the message.

**Note:** The message name can contain a maximum of 31 alphanumeric characters which includes the spaces.



Figure 5-4: New Message Dialog Box

- 4 Press the *Enter* key. The Message Editor screen appears (see Figure 5-5 on page 5-20).

You can set the height of the font, insert user fields in the message editor screen.

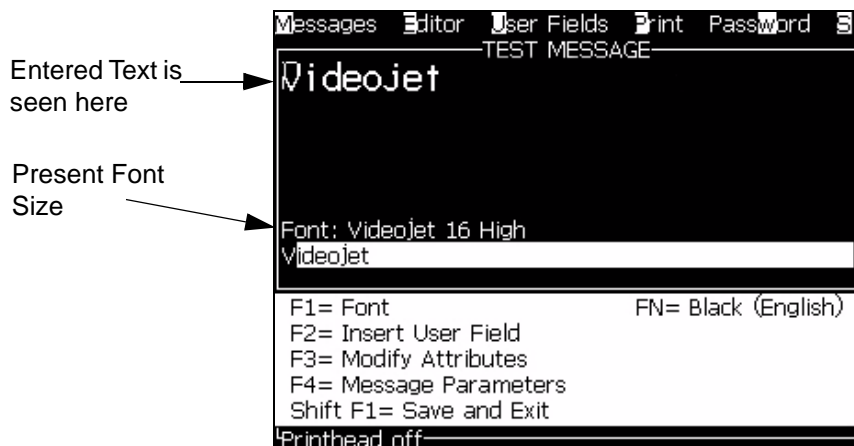

Figure 5-5: Create New Message

### To Edit a Message

Do the following tasks to edit the messages:

- 1 Press the *Alt+M* keys. The *Messages* menu appears.
- 2 From the *Messages* menu, select *Edit Message*. The *Select Message To Edit* menu appears.



Figure 5-6: Select Message to Edit Dialog Box

- 3 Select the message that you require to edit. The Message Editor screen appears.

The function keys are assigned as follows in the Message Editor screen:

 Select font height

*Note:* Videojet 1520 printer has 5, 7, 9, 12, 16, 24 and 34-high fonts.



*Note:* Videojet 1220 printer has 5, 7, 9, 16 and 24-high fonts.

*Note:* The font heights available are independent of language.

 Insert a user field

 Change the attributes

 Set the message parameters

 +  Save the changes and exit the Message Editor

## To Select the Source for a Message

You can set and select the stored messages in the machine by an internal source or an external parallel message selection source.

**Note:** *External message selection feature is not available in the Videojet 1210 printer.*

- 1 Press the *Alt+M* keys. The *Messages* menu appears.
- 2 Select *Message Select Source*. The *Message Select Source* dialog box appears.

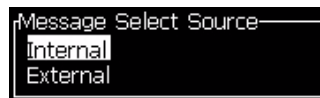

Figure 5-7: Message Select Source Dialog Box

- 3 Use the arrow keys to select the required source - *Internal* or *External*.
- 4 Press the *Enter* key to set the source and return to the Message Editor screen.
- 5 Select the *Messages* menu again.
- 6 Select *Edit External Select Table*. The *External Message Select* dialog box appears.

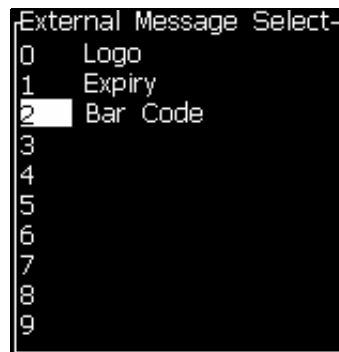

Figure 5-8: External Message Select Dialog Box

- 7 Enter the names into the table locations for the parallel bit values from the external data selection source.
- 8 Press the *F2* key to select the message names from a list of those available.
- 9 When you assign all the messages that must be available to the external source, press the *Enter* key to return to the Message Editor screen. Else, press the *Esc* key to return to the Message Editor screen without any changes.

## To Copy and Paste a Message

If only minor changes are required to an existing message to create a new message, use the *Copy Message* option.

- 1 Press the *Alt+M* keys. The *Messages* menu appears.
- 2 Select *Copy Message*. The *Copy Message* dialog box appears.

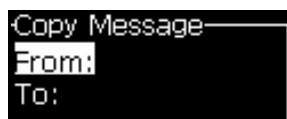

Figure 5-9: Copy Message Dialog Box

- 3 Enter the name of the source message in the *From* box.
- 4 Enter the name of the new message in the *To* box.
- 5 Press the *Enter* key to copy the message and return to the Menu screen.

## To Enter Multiple Lines in a Message

*Note:* The printer automatically selects the best configuration from the message that you entered.

You can enter the messages that have a maximum height of 34 dots (1520 printer) or 25 dots (1220 printer). You can enter multiple lines of text until all lines fit within the allowed height of the message.

Use the *Up* and *Down* arrow keys to move the cursor to the line where you enter the text.

## To Set the Message and Default Parameters

The message parameters define the visual features and position (product delay) of the message.



The different parameters that are available (*Messages > Default Parameters*) are shown in Table 5-10, and Figure 5-10 on page 5-24.

Parameter	Range	Description
Expiry (days ahead)	0 to 32767 days	Sets the expiry date and depends on the selected number of days after the system date of the printer.
	'Display until' date	Sets the number of days for which a product must be displayed for sale.
	'Best Before' date	Sets the number of days before which a product expires. <i>Note: The "Best Before" date has a longer time period than the "Display Until" date.</i>
Hej Exp (days ahead)		Includes the expiration dates and depends on the Arab Hejra calendar.
Width	Refer to Message width and Positioning Addendum	Controls the final message width. The maximum speed of the print puts a limit to the minimum width. Set the width to 1 and print at the maximum rate that you can get for the selected number of "printed drops".
Character Height	1 to 10	Sets the character height at 1 (minimum print height) to 10 (maximum print height).
Character Gap	0 to 9	Sets the character gap between 0 (equivalent to a single vertical line of dots) to 9 rasters/ strokes (equivalent to 10 vertical lines of dots). Because of character formation, setting 0 gives a character gap of 1 raster.
Product** Delay	Refer to Message width and Positioning Addendum	Sets the product delay (the time between the start of product (trigger point) and the print start position).
Reverse	On/Off	Reversed (back to front) character printing.
Invert	On/Off	Inverted (upside down) character printing.
Raster Repeat	1 to 10	Sets the count for the same raster/ stroke is to be printed. This allows characters to be emboldened.
Max Printed dots	1 to 25 Refer to Appendix for more information	Sets the number of dots printed in a raster. If the font specified has a larger value of dots than the printed dots parameter then the print character will be incomplete (truncated). If the font specified has a smaller value of dots than the printed dots parameter then the maximum print speed will be reduced.
Raster Substitution	-	When selected ON the printer automatically selects the appropriate raster for the line running speed.

Table 5-10: Default Message Parameters

Parameter	Range	Description
Select Raster	5-high 7-high 9-high 12 high 16 high 20-high 24-high 25-high 26-high 34-high	Lists the file name of the selected raster.

Table 5-10: Default Message Parameters (Continued)

### To Set Default Parameters

The default values for the parameters are set during the installation, but you can change the values any time.

Do the following tasks to set the default parameters:

- 1 Press the *Alt+M* keys. The *Messages* menu appears.
- 2 Select the *Default Parameters* (Figure 5-10 on page 5-24) to edit the values.

*Note:* The default parameters are applied only to the new messages. The existing messages do not change.

- 3 Select the parameter that you require to edit, and enter the required value.
- 4 When all parameter values are set, press the *Enter* key to return to the Message Editor screen.

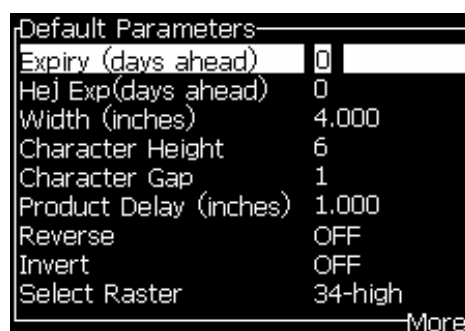

Figure 5-10: Default Parameters Dialog Box

### To Set Message Parameters

When you create and edit a message, you can change the values for the parameters.

Do the following task to set the Message Parameters:

- 1 Press the *Alt + M* keys or the *F4* key (only in *Editor* menu) to open the *Messages* menu.
- 2 Under the *Messages* menu, select the *Message Parameters* (Figure 5-11 on page 5-25) to edit the values.

**Note:** The changes made to the values under the message parameters is applicable only to current messages and not applied to the new messages.

- 3 Select each parameter that you require to edit, and enter the required value. After all the parameter values are set, press the *Enter* key to return to the *Message Editor* screen.

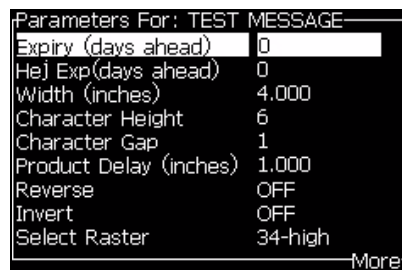

Figure 5-11: Message Parameters Dialog Box

## To Clear a Message



### Caution

**RISK OF DATA LOSS.** The *Clear Message* option, when selected, does not ask for confirmation to clear the message and also, you cannot recover the messages that are cleared.

Do the following tasks to clear all the contents of the message that is edited:

- 1 Follow from Step 1 to Step 3 under the section “To Edit a Message” on page 5-20 to open the *Message Editor* screen.
- 2 Press the keys *Alt+E* to open the *Editor* menu.
- 3 Select *Clear Message* from the *Editor* menu. The message is removed.

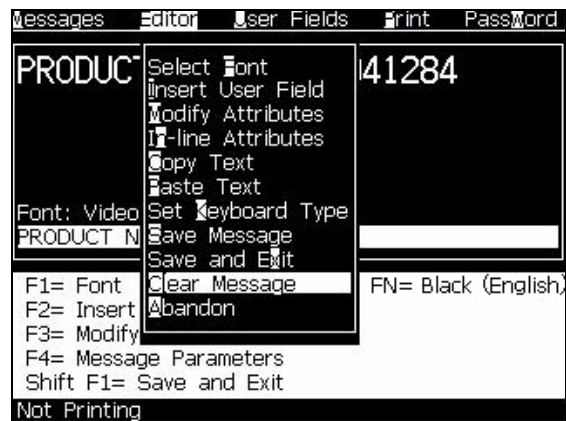

Figure 5-12: Clear Message Option

## To Save a Message

Do the following tasks to save a message:

- 1 Follow from Step 1 to Step 3 under the section “To Edit a Message” on page 5-20 to open the Message Editor screen.
- 2 Press the keys *Alt+E* to open the *Editor* menu.
- 3 Select the option *Save Message* to save the message and also continue to edit the message.

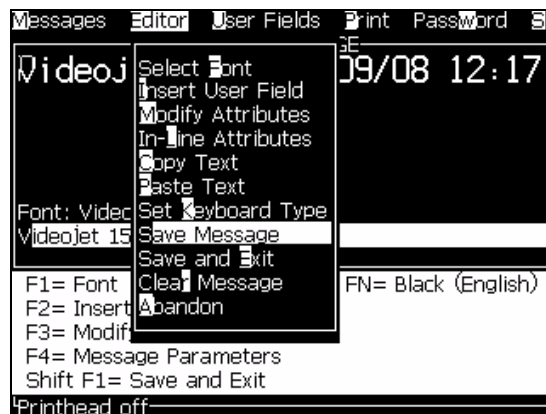

Figure 5-13: Save Message Option

## To Save a Message and Exit

Use either of the two methods to save the message and exit from the Message Editor screen:

- Select *Save and Exit* from the *Editor* menu (see Figure 5-14).

- Press the keys *Shift + F1*.

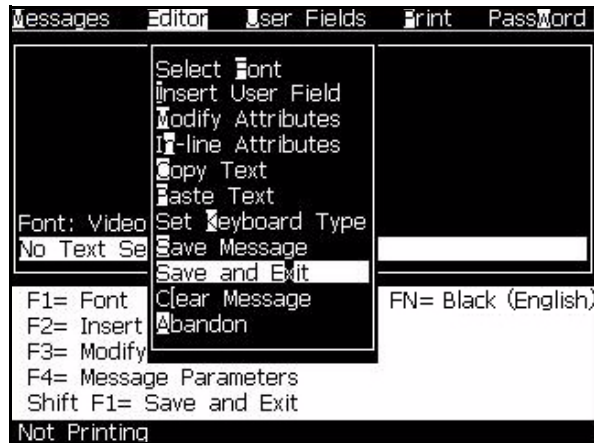

Figure 5-14: Save and Exit Option

## To Exit without Saving the Message

Do the following tasks to exit without saving a message:

- 1 Follow from Step 1 to Step 4 under the section “To Create a Message” on page 5-18 to open the Message Editor screen.

*Note:* When you use this option for a new message, the content of the whole message is lost. If you edit a current message, only the changes are lost.

- 2 Select the *Abandon* option from the *Editor* menu.

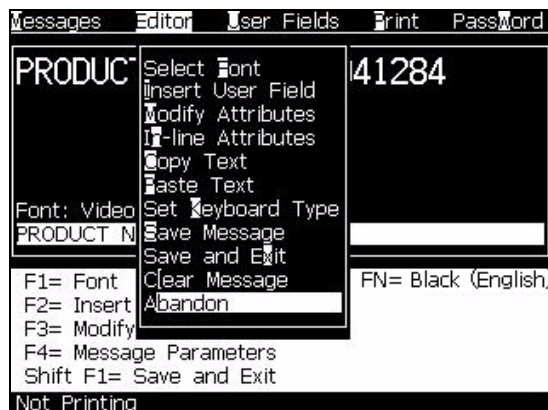

Figure 5-15: Abandon Option

## To Delete a Message

You create more memory space if you can delete some messages.

Do the following tasks to delete the messages:

- 1 Press the *Alt+M* keys. The *Messages* menu appears.
- 2 To delete a single message, select the *Delete Message*. The *Select Message to Delete* dialog box appears.



Figure 5-16: Select Message to Delete Dialog Box

### **Caution**

**RISK OF DATA LOSS.** Make sure to select the correct name. The system does not give any confirmation prompt for the message selection.

---

- a. Use the arrow keys to select the message that you require to delete.
  - b. Press the *Enter* key to delete the message and return to the Menu screen.
- 3 To delete all messages, select the option *Delete All Messages* and press the *Enter* key.

**Note:** All messages except the *TEST MESSAGE* are deleted.

## Manage User Fields

The User Fields contain the information entered by the user. This information can be of any format as follows:

- Text
- Counters
- Logos
- Serial data

**Note:** The clock code and serial data can be considered as text data.

When a user field is inserted into a message, the content of the user field is copied into the message during the print time. When the user field changes, the message is updated automatically and printed.

The pre-defined user fields in the software are described in Table 5-11.

Field Name	Description	Mnemonic Code and Example
Alpha Month	The first three letters in the name of the month during which the message is printed	NOP Example: APR
Date	Prints the system date	06/11/07
Date - YYYY	Same as <i>Date</i> , but shows a 4-digit year	06/11/2007
Day	Prints today's date	FG Example: 14
Day of Week	The day of the week (numerical). You can select which day of the week is set as day 1	A Example: 5
Expiry Alpha Month	Prints the month in MMM format	MAR
Encoded Day of Week	Prints days of the week.	X Example: C for Wednesday
Expiry Date	Prints the system date and the number of days that is offset from the Expiry (days ahead).	07/12/07
Expiry Date - YYYY	Same as to <i>Expiry Date</i> , but shows a 4-digit year	07/12/2007
Expiry Day	Shows the date	14
Expiry Month	Shows the month in numeric form	03
Expiry Year	Shows the 2 digit year	08
Hour	Shows the hour in 24 hour format	HI* Example: 17
ISO Week	Shows the week of the year	
Julian Date	The day of the year (1-365*). *366 days for Leap Year	QRS Example: 152
Julian Week	The week numbers in a year 1 - 52, 53 or 54. (The number of weeks is dependant on the day of the week the 1st January falls and if the year is a leap year).	1-52 (53 or 54)
Minute	The current minute in the current hour - Two characters (A-Z or 1-9)	JK* Example: 05
Month	Shows the month in numeric form	DE Example: 03
Second	Shows the current seconds in the current hour	LM* Example: 57

Table 5-11: List of Pre-defined User Fields

Field Name	Description	Mnemonic Code and Example
Shift	The printer replaces the value here with a shift code during the print time. Set the shifts in the printer to use this field. Refer to "To Set Shifts" on page 5-40.	B
Time	The printer prints the system time	09:06:28
Week of Year	The week of the year on which the message was printed. <b>Note:</b> <i>The first week of the year starts with a week that has 4 days. The second week and all the following weeks begin with the rollover day.</i>	36
Year	Shows the year in YYYY format	hiBC Example: 2010

Table 5-11: List of Pre-defined User Fields (Continued)

\* available for current date/time only

### To Insert a User Field

A user field can contain the following information:

- Current and expiration time
- Dates
- Shift codes
- Text
- Serially loaded data
- A logo (graphic) or a counter

- 1 From the Message Editor screen, press the *F2* key, or select *Insert User Field* from the *Editor* menu. The *Select user field* menu appears.





Figure 5-17: Select User Field Menu

- 2 Select the user field that you require and press the *Enter* key. For example, the *Alpha Month* is shown in the Figure 5-18.

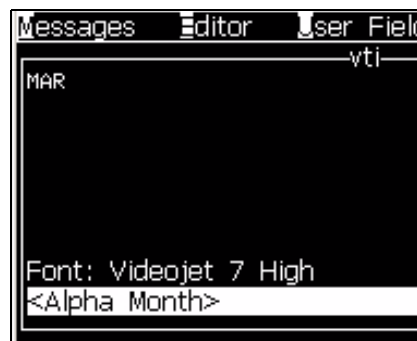

Figure 5-18: User Field - Alpha Month

### To Insert a Pre-defined User Field

Do the following tasks to insert a pre-defined user field:

- 1 Follow from Step 1 to Step 4 under the section “To Create a Message” on page 5-18 to open the Message Editor screen.

*Note:* Make sure that the height of the font and position of the cursor are correct.

- 2 Press the *F2* key in the Message Editor window to open a list that shows all the current user fields that are defined (see Table 5-11 on page 5-29).



Figure 5-19: Pre-defined User Fields

**Note:** The user fields list contains a number of pre-defined user fields with the fields created by the operators and other technicians.

- 3 Highlight the name of the user field you require to insert with the *Up* and *Down* arrow keys.
- 4 Press the *Enter* key to insert the user field into the message and exit the dialog box.

## To Edit a User Field

You can change the content and format of any user field in the list.

To edit a user field, do the following tasks:

- 1 Press the keys *Alt+U* to open the *User Fields* menu.
- 2 Select *Edit User Field*. The *Select user field to edit* dialog box appears.



Figure 5-20: Select User Field to Edit List

- 3 Select the field that you require to edit from the list.  
For example, select *Alpha Month*.
- 4 Press the *Enter* key.

- 5 Edit the code for *Alpha Month* (see *Figure 5-21*). Refer to “To Set Clock Information” on page 5-35 and Table 5-12 on page 5-35 for more information.

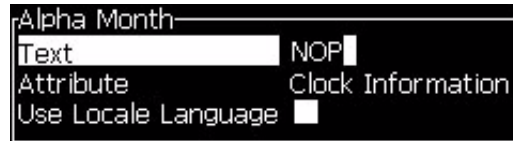

*Figure 5-21: Edit the Code*

### To Delete a User Field

To delete a user field, do the following tasks:

- 1 Press the keys *Alt+U* to open the *User Fields* menu.
- 2 Select *Delete User Field*. The *Delete User Field* list appears.
- 3 Select the field that you require to delete from the list.



#### Caution

**RISK OF DATA LOSS.** The Delete user field option does not ask for confirmation to delete a User Field.

### To Create a Custom User Field

Do the following tasks to create a user field:

- 1 Press the *Alt+U* keys. The *User Fields* menu appears.



*Figure 5-22: User Fields Menu*

- 2 Select *New User Field* and press the *Enter* key. The *New User Field* dialog box appears.

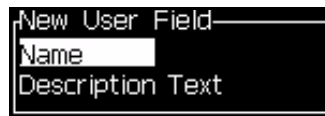

Figure 5-23: *New User Field* Dialog Box

- 3 Enter a name for the *User Field*.

**Note:** Do not press the **Enter** key after you enter the name in the user field. Use the Down arrow key to select one of the types of description.

- 4 Use the *Left* arrow key and *Right* arrow key to select one of the following types of descriptions:
  - Text
  - Counter (refer to “To Set a Counter” on page 5-37)
  - Logo (refer to “To Add Logo” on page 5-38)

For example, you can select the *Text* as the description, and press the *Enter* key.

- 5 Enter the content in the text field.
- 6 Use the *Left* arrow key and *Right* arrow key to select the *Attribute*. Select *Normal Text* as the attribute. You can select one of the following attributes also:
  - Normal Text (refer to “To Set Text Attributes” on page 5-34)
  - Clock Information
  - Prompted Field



Figure 5-24: *Text Attribute*

- 7 Enter the data that you require to print.
- 8 Press the *Enter* key to save and exit.

### To Set Text Attributes

If you select *Text* as the description, you can set the following types of attributes:

#### Normal Text

Normal text is a fixed text string that is used when you insert the serial data.

## Clock Information

### To Set Clock Information

The following table lists the clock codes required to define the clock information.

Code	Definition
A	Day number (1 to 7)
BC	Year
DE	Month
FG	Date
HI	Hours
JK	Minutes
LM	Seconds
NOP	Alpha Month
QRS	Day of Year
TU	North American Week Number
VW	European Week Number

Table 5-12: Codes and Definitions

Do the following tasks to add a clock information attribute to the user field:

- 1 Follow steps 1 to step 3 under the section “To Create a Custom User Field” on page 5-33.
- 2 Select the *Description* as *Text* with the help of *Left* and *Right* arrow keys.
- 3 Press the *Enter* key to open the configuration dialog box for text user fields (see Figure 5-25).



Figure 5-25: Clock Information Option

- 4 Enter the correct code in the *Text* field. Refer to Table 5-12 on page 5-35 for more information.

When you enter the code, remember the following:

- a. These codes are case-sensitive.
- b. The standard date codes are from the Gregorian calendar used by western nations. The Arab Hejra calendar uses different date codes.

- c. You can add other characters like numbers, spaces, punctuation marks to format the codes. For example, DE/FG/BC.

**Note:** Clock codes with lower case represents expiry dates of the same code definition.

- 5 Select the *Attribute* as *Clock Information*.
- 6 Press the *Enter* key after you enter the codes to save the settings and exit the *Time Insert* dialog box.

The new clock insert is added in the list of defined user fields. Press the *F2* key in the Message Editor screen. You can insert this new field in the current message.

### Prompted Fields

Prompted fields define the content that can change each time the message is used. The content can include a message of the day or other content that is related to a known run of the product, but remains the same for that complete run.

#### To Define a Prompted Field

When a message that contains a prompted field is loaded, the operator is asked to provide the contents for the field.

Do the following tasks to add a prompted field in User fields:

- 1 Follow steps 1 to 3 under the section “To Create a Custom User Field” on page 5-33
- 2 Highlight the *Description* option through *Down arrow* key.
- 3 Select the *Text* option through *Left* and *Right arrow* keys.
- 4 Press the *Enter* key to open the configuration dialog box for text user fields (Figure 5-26).



Figure 5-26: Attribute - Prompted Field

- 5 Enter a default value for the prompted field which is related to the field with the label *Text*. This text is displayed in the prompted field until the operator deletes the text and enters new information.
- 6 Highlight *Attribute* option using the *Down arrow* key.
- 7 Select the *Prompted Field* option with the help of *Left* and *Right arrow* keys.

- 8 Press the *Enter* key to open the *Prompted Field Length* window (see Figure 5-27).



Figure 5-27: Prompted Field Length Dialog Box

- 9 Enter the maximum length of the prompted field in the space provided (any number less than or equal to 50 is allowed here).

*Note:* If a number greater than 50 is added, then the printer automatically decreases the number to 50.

- 10 Press the *Enter* key to save the created prompted field and exit the *Prompted Field Length* dialog box. Refer to “To Modify Text Attributes” on page 5-46 for more information.

### To Set a Counter

The counters (serializers) are fields that change their value by a fixed amount. When a specified event occurs, the value changes by that fixed amount. For example, counters help to print different serial number on each product that passes the production line.

Do the following tasks to add counter as User field:

- 1 Follow steps 1 to 3 under the section “To Create a Custom User Field” on page 5-33.
- 2 Highlight the *Description* option with the help of the *Down arrow* key.
- 3 Select the *Counter* option with the help of *Left* and *Right arrow* keys.
- 4 Press the *Enter* key to open the counter dialog box for counters (see Figure 5-28).

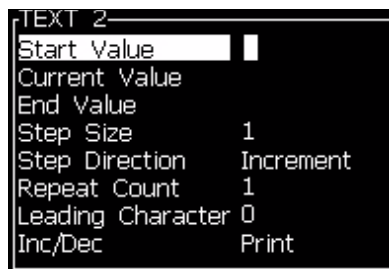

Figure 5-28: New Counter Dialog Box

- 5 Set the values for all the fields in the *Counter Configuration* dialog box (see Figure 5-28).

**Note:** The *Start Value*, *Current Value*, and *End Value* fields must contain the same number of characters. If a new counter counts from 1 to 500, make sure to enter 001 instead of 1 in the *Start Value* and *Current Value* fields.

The counters are in numerical, alphabetical or alphanumeric format. The system automatically selects the type of counter from the start, current and end values configured. Alphanumeric counters count 0 to 9 and A to Z.

- 6 Press the *Enter* key to save the settings, and exit the *Counter Configuration* dialog box.

### Counter Field Definitions



Field Name	Definition
Start Value	The value from where the count starts. When the value is reset, the counter returns to this value.
Current Value	The counters current value. This field changes the current value of a counter that is used now. When you set a new counter, the value entered here must be identical to the Start Value.
End Value	The value that the counter reaches at the end of the count. The counter resets to the start value, the next time it increases.
Step Size	The number of units with which the counter increases or decreases. The size is a numerical value even for alphabetical counters (a value of 2 causes an alphabetical counter to count "a, c, e, g").
Step Direction	Set to Increment or Decrement
Repeat Count	The number of times that a count value is printed before the value increments or decrements.
Leading Character	Define another character to replace any leading zeros. The default setting is "0" and the leading zeros remain the same.
Inc/Dec on	This field shows the causes for the counter to increment or decrement itself. Select <i>Print</i> to show that the counter has increased or decreased if a message that contains the counter is printed. Select the name of another counter to show that the counter is increased or decreased, when the selected counter reaches its End Value

- 7 Press the *Enter* key to save and close the new counter field.

### To Add Logo

Refer to "To Modify Text Attributes" on page 5-46 for more information.



- 1 Follow steps 1 to 3 under the section “To Create a Custom User Field” on page 5-33.
- 2 If you select the *Logo* as the description, the *Logo Editor* screen appears.
- 3 Press *Spacebar* on the keypad to turn on  or turn off  the cursor.

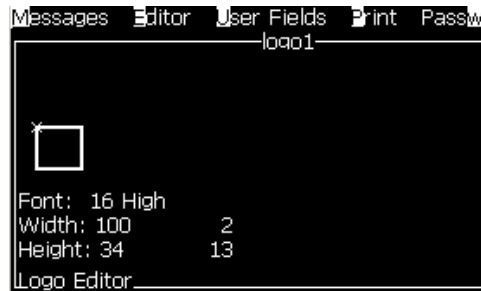

Figure 5-29: Edit Logo Screen

- 4 Create the logo by drawing lines with the help of the key combinations shown in Table 5-13 on page 5-39.



















Key Combination	Cursor Movement
 or  or  or 	Moves the cursor one dot at a time and not draw a line.
 +  or  or  or 	Moves the cursor ten dots at a time and not draw any line.
 +  or  or  or 	Moves the cursor one dot at a time and draws a line.
 +  or  or  or 	Moves the cursor one dot at a time and deletes any dots drawn.

Table 5-13: Key Combinations for Logo Creation

- 5 When your logo is complete, press *Shift + F1* key to save and close your logo.

## To Reset a Message Counter

Do the following tasks to reset a message counter to its start value:

- 1 Press *Alt+U* to open the *User Fields* menu.
- 2 Select the *Reset Counter* option (see Figure 5-30).



Figure 5-30: Select Reset Counter

- 3 The *Select Counter to Reset* menu appears.

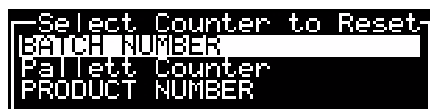

Figure 5-31: Select Counter to Reset

- 4 Select the counter that you want to reset and press the *Enter* key.

## To Set Shifts

Use the *Set Shift* option to set the hour and minute for shift. The operator can set the hour and minute for five shifts. You can set the character also for the shifts.

Do the following to set up the shifts:

- 1 Select *User Fields* from the menu bar, and press the *Enter* key.
- 2 Select *Set Shifts* from the *User Fields* menu.
- 3 Press the *Enter* key to open the *Set Shifts* dialog box (Figure 5-32 on page 5-41).
- 4 Set the start time for each shift that you require to use (start with shift 1) with the help of *Up* and *Down* arrow keys. For example, to set a start time of shift 1 as 7:15 A.M., set Start hour of shift one to seven and Start minute of shift one to 15.
- 5 Select the start time fields of the consecutive shifts using the arrow keys, and enter the necessary values (see step 4).

**Note:** Hour values depend on the 24-hour clock. For example, the entry “15” is for 3:00 PM which is the start time of the shift.

**Note:** The start time of the shift 2 must be after the start time of shift 1. When shift 3 is set, the start time must be after the start times of shifts 1 and 2.

**Note:** Shifts must be consecutive (you cannot set the timings for shift 1 and shift 3, and exclude Shift 2).

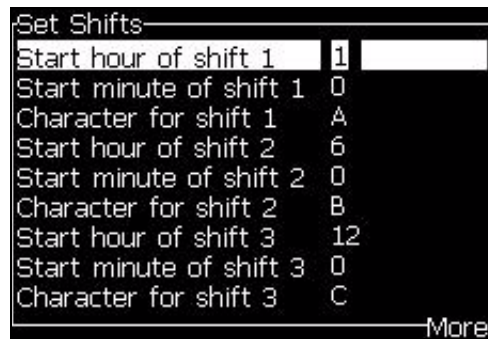

Figure 5-32: Set the Shifts

- 6 Enter “0” for both the start hour and the start minute of the first shift that you do not require. The shifts that follow are not used.
- 7 Enter the character that stands for the first shift in the Character for shift 1 field. This character that is for the current shift that is inserted in the messages during print. The printer counts upward from that character forward to get the remaining shift codes. An example of shift codes is shown in Table 5-14.

Value Entered	Shift 1	Shift 2	Shift 3	Shift 4	Shift 5
A	A	B	C	D	E
1	1	2	3	4	5
4	4	5	6	7	8
d	d	e	f	g	h

Table 5-14: Shift Codes

- 8 Press the *Enter* key to save the settings and exit the *Set Shifts* Menu.

## Manage Text

### To Change Font Case

The required message can contain both upper and lower case characters. The keys on the keypad that control the case of the entered characters are shown in Table 5-15.



Key	Function
	The <i>Caps</i> Key changes the case of the next character entered.
	The <i>Caps Lock</i> key changes the default case.

Table 5-15: The keys to Change the Case of the Fonts

### To Set Font Height

You can change the height of the font in a message and can have more than one size in a message. The number of lines in a message depends on the size of the font selected and the model of the printer. Refer to “Font Specifications and Line Speeds” on page A-9 for more information.

Press the *F1* key until you get the required height of the font (see Figure 5-33).



Figure 5-33: Select Font Height

Do the following tasks to set the height of the font from the *Editor* menu.

- 1 Press the *Alt+E* keys or press *F1*. The *Editor* menu appears (see Figure 5-34).

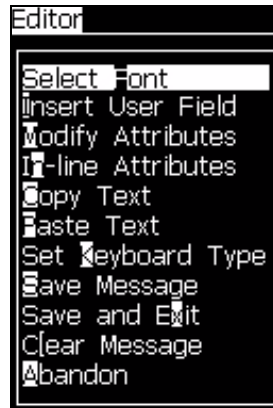

Figure 5-34: Editor Menu

- 2 Select the *Select Font* option. The *Select Font* menu appears. Use the *Up* and *Down arrow* keys to select the height of the font.

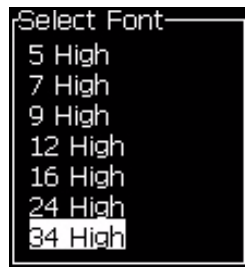

Figure 5-35: Select Font List

- 3 Select the font height, and press the *Enter* key.

### To Select Content

The editor automatically selects the block of text that you enter. This feature is referred to as *Default Text Selection* (Figure 5-36). If this feature is not available, the message *No Text Selected* appears in that area.



Figure 5-36: Text Selection

Press *Ctrl + Left arrow key* or *Ctrl + Right arrow key* to highlight the required text.

## To Copy and Paste Text

You can copy some text to the clip board and paste the text in a different area.

### To Copy Text

Do the following tasks to copy the text.

- 1 Press the *Alt+M* keys. The *Messages* menu appears.
- 2 Select *Edit Message*. The *Select Message To Edit* dialog box appears (see Figure 5-37).

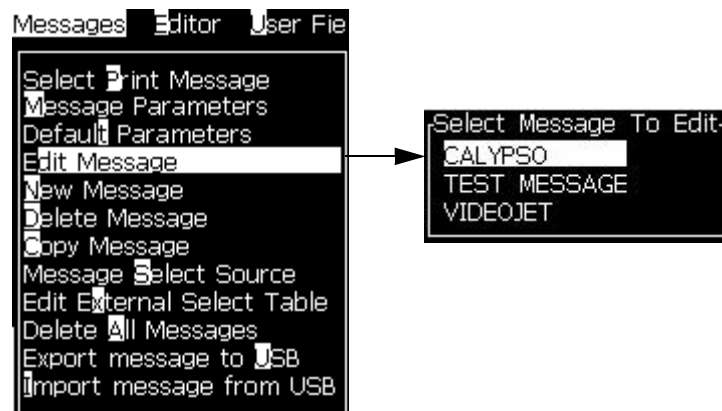

Figure 5-37: Edit Message Option

- 3 Select the message and press the *Enter* key. The message editor screen appears.

- 4 Press the *Ctrl + Left* arrow key or *Ctrl+ Right* arrow key to highlight the required text.
- 5 Press the keys *Alt +E* to open the *Editor* menu.
- 6 Select *Copy Text* from the *Editor* menu.

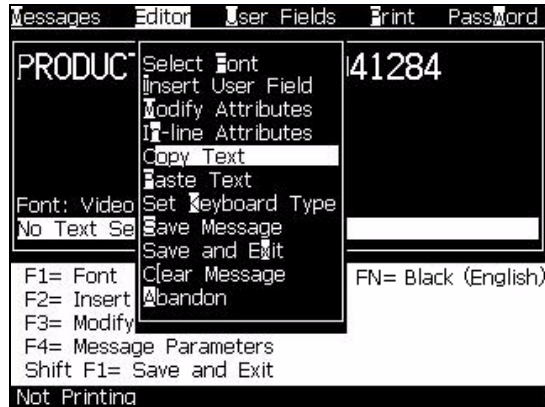

Figure 5-38: Copy Text Option

### To Paste Text

Do the following tasks to paste the text:

- 1 Follow from Step 1 to Step 3 under the section “To Copy Text” on page 5-44 to access the *Editor* screen.
- 2 Set the cursor at the point in the message where you require to paste the text.
- 3 Press the keys *Alt+E* to open the *Editor* menu.
- 4 Select the option *Paste Text* from the *Editor* menu.



Figure 5-39: Paste Text Option

## To Modify Text Attributes

There are two methods to change the text attributes:

- **Modify Attributes** - The *Modify Attributes* option allows the operator to change the attributes of the selected content displayed in the editor screen (refer to “To Modify Attributes” on page 5-47).
- **In-line Attributes** - The *In-line Attributes* option applies the changes only to the new text entered at the cursor and any selected text is ignored (refer to “To Apply In-line Attributes” on page 5-48).

The different attributes are recorded in Table 5-16.







Options	Functions	Example
Invert	Turns the text upside down.	
Reverse	Turns the text back to front.	
Use Custom Font (Videojet 1520 only)	Contact Videojet for more information.	
Clock	Changes the text to the date or time information. For example, if you enter FG-DE-BC, you get the date in dd-mm-yy format.	
Double Dot	Each raster of selected text is made to print two times that forms bolder character. Example: See “Bold Text” in the illustration.	
Triple Dot	Each raster of selected text is made to print three times to make the character very bolder. Example: See “Very Bold Text” in the illustration.	
Tower print	The printer can print single line (5 x 7) in the vertical direction.	
Barcode (Videojet 1520 only)	Turns the inserted text into the format of the required barcode.	

Table 5-16: Options to Modify Attributes



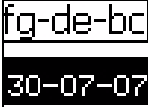

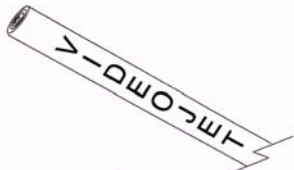
Options	Functions	Example
Check sum (Videojet 1520 only)	A check sum is a value used to make sure data is stored or transmitted without an error. If the check sum option is enabled, the system creates this digit automatically. Example: The last digit of the bar code is an optional check sum digit.	 The digit 0 in the above barcode is the checksum.
Human Readable (Videojet 1520 only)	Allows the human readable portion of the barcode data to be printed below the barcode or turned off.	
White on Black (Videojet 1520 only)	Use this option to invert the colors on the barcode.	
Datamatrix Density (Videojet 1520 only)	Use this option to set the size for the Data Matrix symbol.	Data Matrix after the UI encoded the text (32 x 32) 'Videojet' 

Table 5-16: Options to Modify Attributes (Continued)

### To Modify Attributes

**Note:** You can apply more than one attribute to the selected content.

Do the following tasks to change the text attributes:

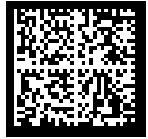
- 1 Select the content in the menu editor. You can select the text in the following methods:
  - a. Set the cursor at the required position in the text and press the *Enter* key.
  - b. Press the *Ctrl + Left arrow key*, or *Ctrl + Right arrow key* to highlight the required text.
- 2 Press the *F3* key to open the *Editor Attributes* screen. You can adjust the attributes of the selected text.

**Note:** The editor attributes *Use custom font*, *Tower print*, *Barcode*, *Check sum*, *Human Readable*, and *Datamatrix Density* are not available in *Videojet 1210 printer*.

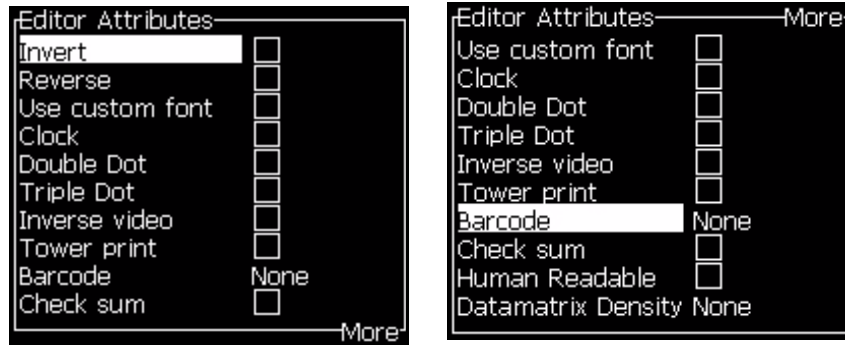

Figure 5-40: Editor Attributes Menu

- 3 Press the *Up arrow* key or the *Down arrow* key until the required attribute is selected (shown by the cursor under the first letter of the attribute name).
- 4 Press the *Right arrow* key to select the attribute, and press the *Left arrow* key to cancel the attribute.  
  
You can also use the space bar to select or cancel the attributes.
- 5 When all the required attributes are set, press the *Enter* key to save the settings and return to the Message Editor.

### To Apply In-line Attributes

**Note:** You can apply more than one attribute for the selected content.

Do the following tasks to change the attributes of the text:

- 1 Select *In-line Attributes* from the *Editor* menu (press *ALT + E*). The *Editor Attributes* menu appears.
- 2 Select the required attributes and press the *Enter* key. The changes made are saved and you exit the *Editor Attributes* menu.

### To Insert a Barcode

Do the following tasks to insert a Barcode:

**Note:** Refer to “Barcode Specifications” on page A-11 for more information on the type of barcodes that are allowed.

- 1 Press the *F1* key until the size of the font for the barcode you require is displayed.

**Note:** When the height of barcode is less than 16 drops, the printer does not allow the operator to print human readable elements of barcodes.

- 2 Press the *F3* key or *ALT + E* and select *In-line Attributes* to open the *Editor Attributes* screen (see Figure 5-41 on page 5-49).

- 3 Use the *Up* and *Down arrow* keys to highlight the *Barcode* option.
- 4 Use the *Right arrow key* or *Left arrow key* to select the required barcode.

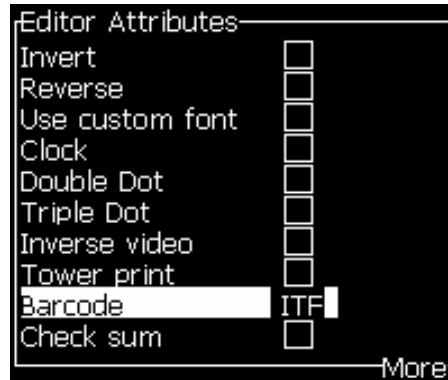

Figure 5-41: Select the Type of Barcode

- 5 If you require to include a check sum for error correction in the barcode, then use the *Right arrow key* or *Left arrow key* to select the box.

**Note:** If you cannot highlight the check sum now, the current setting is necessary for the type of barcode selected.

- 6 If you require a human readable version of the barcode to appear near the barcode, press the *Right arrow* or *Left arrow key* to select the relative position on the *Human Readable* attribute:

**Note:** If you cannot highlight Human Readable now, the current setting is necessary for the type of barcode selected and size of the font.

- 7 Press the *Enter* key to save the barcode and exit the *Editor Attributes* screen.
- 8 Enter the barcode data at the cursor. A graphical representation of the barcode now appears in the Message Editor window.

For example, you can see some useful information about the input allowed for the type of barcode (EAN-8) selected.

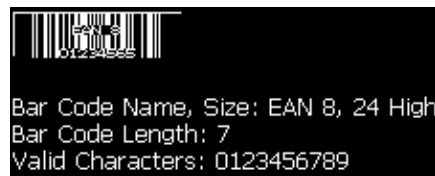

Figure 5-42: Bar Code

**Note:** You can insert a user field into a barcode if all the characters in this field are valid for the type of barcode.

- 9 Finish the barcode edition and move the cursor away with the *Left arrow* or *Right arrow key*.

## To Insert Foreign Language Characters

You can include the characters from more than one language alphabet in a message.

Do the following tasks to insert foreign language characters:

- 1 Follow Step 1 to Step 4 under the section “To Create a Message” on page 5-18 to open the Message Editor screen.
- 2 Press the *Alt + E* keys to open the *Editor* menu.
- 3 Select *Set Keyboard Type* from the *Editor* menu. The *Select Kbd Type* menu appears.

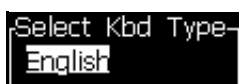

Figure 5-43: Select Keyboard Type Menu

*Note:* If the required keyboard type is not shown, you must change the *Editor Font Group*. You must change before the jet is started, because the change to the *Editor Font Group* always includes a power cycle.

- 4 Select the required type of keyboard from those available and press the *Enter* key. The Message Editor screen appears.

*Note:* You can use the alphabet of the selected language in the message that is edited.

Repeat the procedure to return to the original keyboard after you enter the special characters.

## Manage Logos

### To Download a Logo

Logos can be downloaded using a USB stick, but make sure that the file format is monochrome bitmap file.

*Note:* The USB connector is an optional port for Videojet 1220 printer. For more information, contact the Videojet distributor or subsidiary.

When you download a logo, the printer prompts with the following message:

“The *logo editor* is opened and the UI displays the logo with assigned file name.”

*Note:* The logo will be clipped at the top or bottom, if it is more than 34 dots high (1520) or 25 dots high (1220).

You can edit the logo on the printer, or use the *Shift + F1* option to save the logo with the same name. The logo is available under the User Fields to insert into the messages.

**Note:** If you try to download a type of file (or folder) which does not match the file types, in the above table, the printer displays the following if the **Enter** key is pressed "Unsupported File Type".

## To Create a Logo in Microsoft Paint Application

- 1 Open the Microsoft Paint application. A new page opens by default.
- 2 Navigate to *View > Zoom > Custom*. The *Custom Zoom* (Figure 5-44) dialog box appears.
- 3 Select 800% under *Zoom to*. Click the *OK* button.

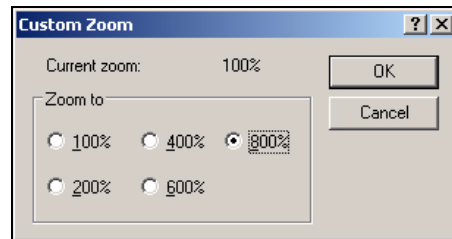

Figure 5-44: Custom Zoom

- 4 Navigate to *View > Zoom > Show Grid* to activate the grid for the page.
- 5 Navigate to *Image > Attributes* to set the size of the message. Set the necessary message size. The message height should not be more than 34 for 1520 and not more than 24 for 1220. This menu allows the user to:
  - a. Verify the format of the existing messages.
  - b. Pre-set the message size to avoid editing the image later
  - c. Select the colour format of the image as *Black and White*. (See Figure 5-45 on page 5-52)

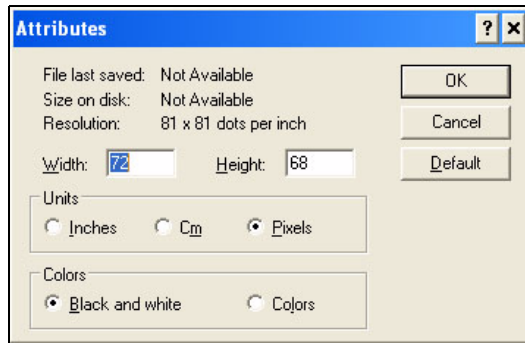

Figure 5-45: Image Attributes

- 6 Create the required logo on the page (see Figure 5-46).

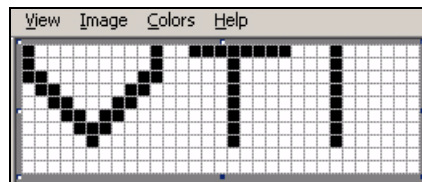

Figure 5-46: Logo Created on Microsoft Paint

**Note:** If the logo size is bigger than required, navigate to *Image > Stretch/Skew*. Enter the appropriate values to stretch/skew the images in vertical and horizontal directions (Figure 5-47). Ensure to enter equal values in horizontal and vertical columns.

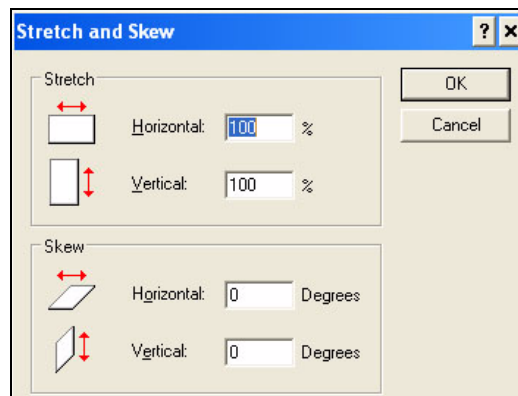

Figure 5-47: Image stretch and skew

- 7 Save the created logo as monochrome bitmap file in the USB.
- 8 Insert the USB drive into the USB port on the printer.

- 9 Press *Ctrl + F4* on the menu screen of the UI and the *Files on USB drive* appear.



- 10 Press the *Enter* Key and the logo appears on the menu screen (see Figure 5-48 on page 5-53).



Figure 5-48: Logo on Menu Screen

**Note:** Make sure that the Height and Font values are not set at Zero.

### To Use the Logo Editor Menu

Press *Alt+E* (*Editor* menu) in the *Logo Editor* screen to display the *Logo Editor* menu.

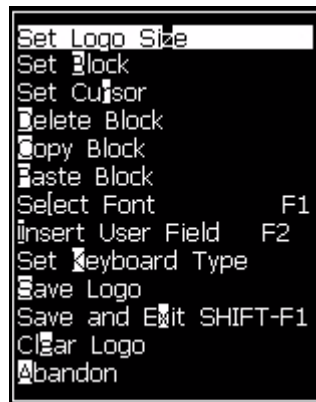

Figure 5-49: Logo Editor Menu

This menu contains the following options:

### To Set Logo Size

You can change the size of the logo after you insert the logo.

Use the keys shown in the Table 5-17 to change the size of the logo:









Keys used	Setting
 or  and  or 	Adjust the width of the logo one dot at a time. Adjust the height of the logo one dot at a time.
 +  ,  ,  , 	Adjust the logo size ten dots at a time.

Table 5-17: Setting Logo Size



Do the following tasks to crop a graphic:

- 1 Press the *Enter* key and a frame appears that shows the current boundaries of the graphic (see Figure 5-50).

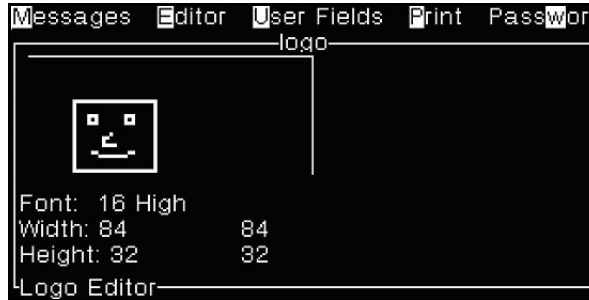

Figure 5-50: Crop Logo

- 2 Adjust the size of the frame with a combination of controls, until boundaries of the graphic are as required. Refer to Table 5-18 on page 5-55 for the controls used and their functions.

**Set Block**

Sets a block over the logo editor screen that you can move and change the size. You can cut, paste, or delete the text or graphics enclosed by the block.



Figure 5-51: Logo Editor

Press the following keys to adjust the block:









Keys	Setting
 +  or 	Move the right-hand edge.
 +  or 	Move the left-hand edge
 +  or 	Move the top edge.

Table 5-18: Set Block

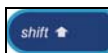









Keys	Setting
 +  or 	Move the bottom edge.
 ,  ,  or 	Move the whole block by one dot at a time.
 +  or 	Move the whole block by ten dots at a time.

Table 5-18: Set Block (Continued)

Press the *Enter* key to set the position and size of the block. The outer line of the block disappears from the screen.

**Set Cursor**

The cursor returns to a single pixel mode instead of a block.

**Delete Block**

Deletes any text or graphics within the area of the block.

**Copy Block**

This function copies any text or graphics within the area of the block and saves the information to the clip board.

**Paste Block**

Inserts the contents of the clip board at the cursor position.

**Select Font**

Selects the height of the font for use when you combine the text with a logo.

Press the *F1* key to select the option *Select Font*.

**Insert User Field**

Allows the user to combine a user field with a logo.

Press the *F2* key to select the option *Insert User Field*.

**Set Keyboard Type**

Displays the languages available for the keyboard. To select a keyboard type, highlight and press the *Enter* key. The message is edited now using the selected keyboard type.

**Save**

Saves the logo to the memory and the program remains in the Logo editor screen.

**Save and Exit**

Saves the logo in the memory and returns to the previous screen. Press *Shift + F1* to select the option of Save and Exit.

***Clear Logo***

Removes the logo that is edited at this time or created from the Logo Editor screen.

***Abandon***

Leaves the logo edition activity without saving any changes, and returns to the Message Editor Screen.

## Introduction

The maintenance of the printer includes the procedures that an operator or a service technician can perform. This chapter describes the maintenance tasks that the operators of the printer are allowed to perform. The other maintenance tasks that only the trained service technicians and personnel must perform are described in the Service Manual.



### Warning

PERSONAL INJURY. It is possible that in a fault condition, heater can reach 70° C. Do not touch the plate on which heater is installed. The failure to follow this warning can cause the personal injury.

## Maintenance Schedule

Table 6-1 shows the maintenance schedule.

Interval	Task
When the printer is commissioned or if the make-up cartridges are empty	Replace the smart cartridge. Refer "Replace Smart Cartridges" on page 6-4.
As Required	Clean the following parts of the printhead: <ul style="list-style-type: none"><li>• Deflector Plate</li><li>• Gutter</li></ul> <b>Note:</b> Check the quality of the print before you do the maintenance. Refer "Inspect the Printhead" on page 6-6, and "Clean the Printhead" on page 6-7.
	Clean the printer cabinet.
Every 2000 Hours	Replace the back filter.

Table 6-1: Maintenance Schedule

## Preparation for Long-term Shutdown (Storage) or Transportation

*Note: Long term Shutdown procedure should be used when the printer will not be used for more than 10 days.*

### Parts/tools Requirement

Parts/Tool	Quantity	Part Number
Make-up Cartridges matching existing make-up in ink core which will be flushed	4	-
Empty Cartridges	6	SP399246
Nozzle Bypass Manifold (Loop Connector) Kit with gasket	1	399247

Table 6-2: Parts and Tools

### How to Prepare for Long-term Shutdown (Storage) or Transportation

Do the following tasks to prepare the printer for long-term shutdown/transportation:

- 1 Perform a Clean Stop.
- 2 Run three nozzle flushes.
- 3 Remove the Nozzle Manifold, and attach the Nozzle Bypass Manifold (with gasket) to it. Perform Empty Core Procedure.

*Note: Printhead needs to be placed over a wash station or a suitable container to capture any overspill.*

- 4 After core procedure completes, run the *Flush Ink Core* procedure and follow the printer instructions.

*Note: The total time to complete this process is approximately three hours. It will require four sets of cartridges, each cartridge set is attached for 30 to 45 minutes. Each set, upon completion, will be half full with mixed fluids.*

- 5 Remove the Nozzle Bypass Manifold and fix the Nozzle Manifold with the gasket from the print engine deck.

The printer is now ready for storage or transportation.

**Note:** When the ink core has been refilled with the ink removed for storage, do not recalibrate viscosity on re-install as the calibration data has been saved.

**Note:** While preparing the printer for long term shut down, for Level 3 password, please contact Videjet Technologies Inc. Customer Service Department at 800.843.3610 (United States only), or contact the local Videjet Technologies Inc. representative for more information. Alternatively, you can visit [www.videojet.com](http://www.videojet.com)>Support>Videjet Password Generator.

## Replace Smart Cartridges

There are two types of smart cartridges:

- Ink cartridge
- Make-up fluid cartridge

The user has to install the cartridges when the printer is commissioned or when the cartridges are empty. The type of fluid (ink or make-up fluid) is written on the cartridge labels.

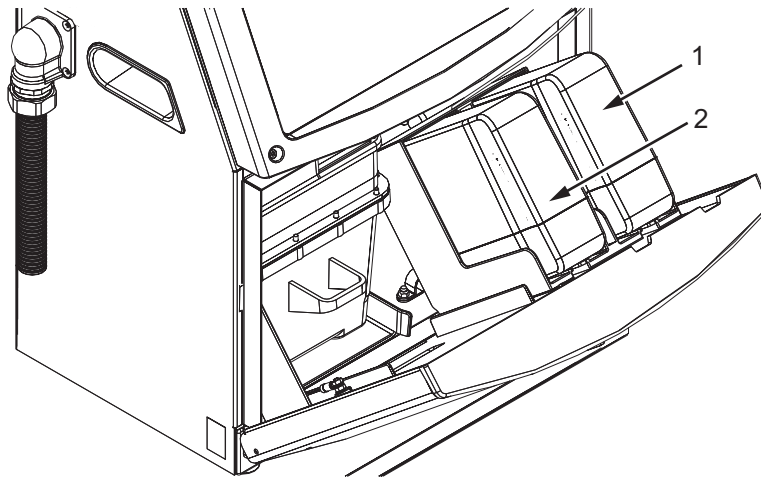

1. Ink Cartridge
2. Make-up Fluid Cartridge

Figure 6-1: Smart Cartridges

To add or replace the cartridges, do the following tasks:

- 1 Open the door of the ink compartment, and keep the door in the position shown in the Figure 6-1.
- 2 If the ink and make-up fluid cartridge indicators show empty status

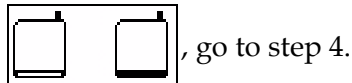

- 3 If the ink or make-up fluid cartridge is not loaded icon appears

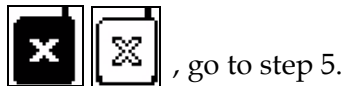



## Warning

PERSONAL INJURY. All fluids like the ink, solvent and make-up fluid are volatile and flammable. They must be stored and handled according to local regulations. Work only in areas with good ventilation. The cleaning solution is poisonous if taken internally. Do not drink. Seek medical attention immediately if ingested.

- 4 Pull the old ink cartridge (item 1, Figure 6-2 on page 6-5) and the old make-up fluid cartridge (item 2) out of the printer cabinet.

*Note: Shake the ink cartridge before inserting it into the printer.*

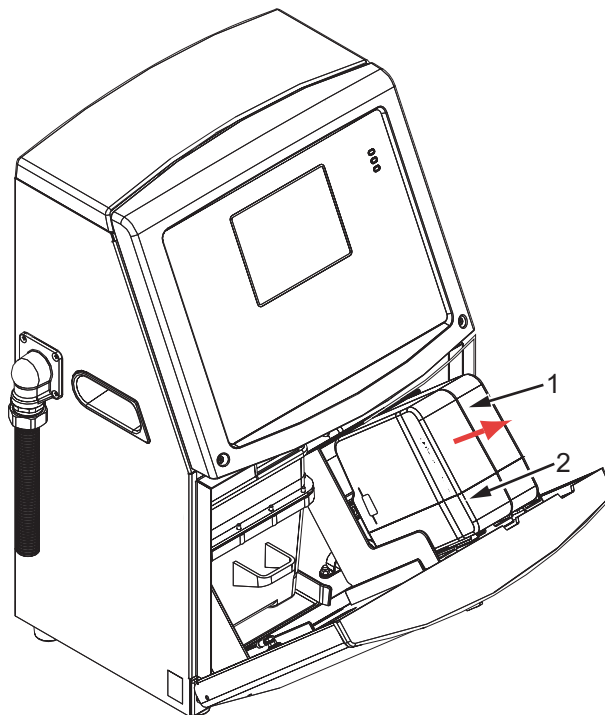

1. Ink Cartridge
2. Make-up Fluid Cartridge

Figure 6-2: Pull out the Cartridges

- 5 Insert the new ink cartridge into the ink cartridge holder by aligning the cartridge key with the correct holder slot (see Figure 6-3 on page 6-6).
  - a. Make sure that the cartridge is engaged completely in the holder.

*Note: Push the cartridge until the cartridge locks into the cartridge holder (that is till you hear a snap sound).*



- b. Make sure that the icon that indicates “ink cartridge not loaded” disappears. The icon can take some seconds to disappear.
- c. Make sure that the cartridge level indicator 100% full appears

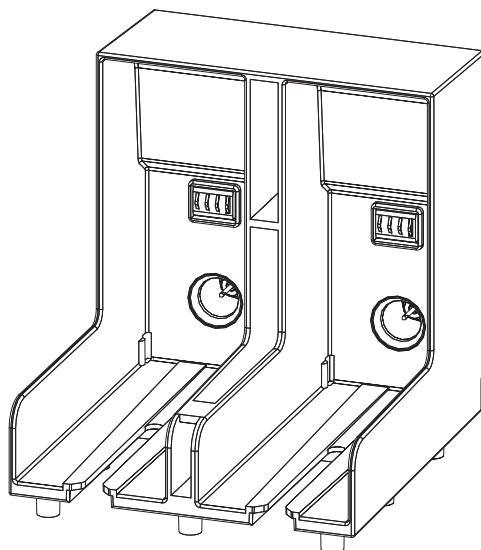

Figure 6-3: Cartridge Holder Slot

- 6 Insert the new make-up fluid cartridge into the make-up fluid cartridge holder by aligning the cartridge key with the correct holder slot.
  - a. Make sure that the cartridge is engaged completely on the holder.
  - b. Make sure that the icon that indicates “make-up fluid cartridge not loaded” disappears. The icon can take some seconds to disappear.
  - c. Make sure that the icon that indicates “cartridge level 100% full”

appears .

## Inspect the Printhead

Do the following tasks to inspect the printhead:

- 1 Stop the ink jet and wait for the printer to completely shutdown.
- 2 Disconnect the printer from the power supply.
- 3 Loosen the printhead screw (item 2, Figure 6-4 on page 6-9 and Figure 6-5 on page 6-9) and remove the printhead cover (item 3).

- 4 Inspect the printhead and the inside of the printhead cover for any ink deposits. Clean if necessary (refer “Clean the Printhead” on page 6-7).

## Clean the Printhead



### Warning

**PERSONAL INJURY.** In the event of an ink or solvent spill, leakage from the printer could cause a floor/slip hazard and/or fire hazard (particularly if the equipment is situated over flammable material and/or other equipment). An optional drip tray is available (Part Number 234407). To install, place the drip tray on surface that the printer is to be used. Place the printer in the centre of the drip tray. Ensure that the drip tray is appropriately grounded to avoid static build up.



### Warning

**VAPOUR HAZARD.** Prolonged breathing of cleaning solution vapor can cause drowsiness and/or effects like alcoholic intoxication. Use only in well ventilated, open areas.



### Warning

**HANDLING CLEANING SOLUTION.** The cleaning solution is irritating to the eyes and respiratory system. To prevent personal injury when handling this substance:

Always wear protective rubber gloves and clothing.

Always wear goggles with side-shields or a face mask. It is also advisable to wear safety glasses when carrying out maintenance.

Apply barrier hand cream before handling ink.

If cleaning solution contaminates the skin, rinse off with running water for at least 15 minutes.

 **Warning**

FIRE AND HEALTH HAZARD. The cleaning solution is volatile and flammable. It must be stored and handled in accordance with local regulations.

Do not smoke or use a naked flame in the vicinity of the cleaning solution.

Immediately after use remove any tissues or cloth that are saturated with cleaning solution. Dispose off all such items in accordance with local regulations.

---

 **Caution**

EQUIPMENT DAMAGE. To prevent the damage to the printer components, use only soft brushes and lint free cloths to clean the printer. Do not use high-pressure air, cotton waste or abrasive materials.

---

 **Caution**

EQUIPMENT DAMAGE. Make sure that the cleaning solution is compatible with the ink used before you clean the printhead. The failure to follow the caution can damage the printer.

---

*Note: Make sure that the jet is turned off.*

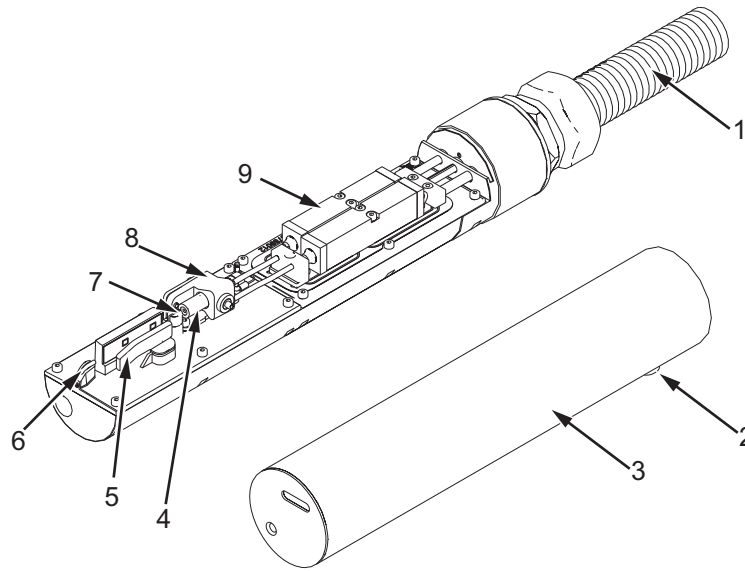

- |                           |                                  |
|---------------------------|----------------------------------|
| <b>1. Umbilical</b>       | <b>6. Gutter Sensing Tube</b>    |
| <b>2. Printhead Screw</b> | <b>7. Charge Electrode</b>       |
| <b>3. Printhead Cover</b> | <b>8. Printhead Engine</b>       |
| <b>4. Nozzle</b>          | <b>9. Printhead Valve Module</b> |
| <b>5. Deflector Plate</b> |                                  |

Figure 6-4: Printhead (Videojet 1220)

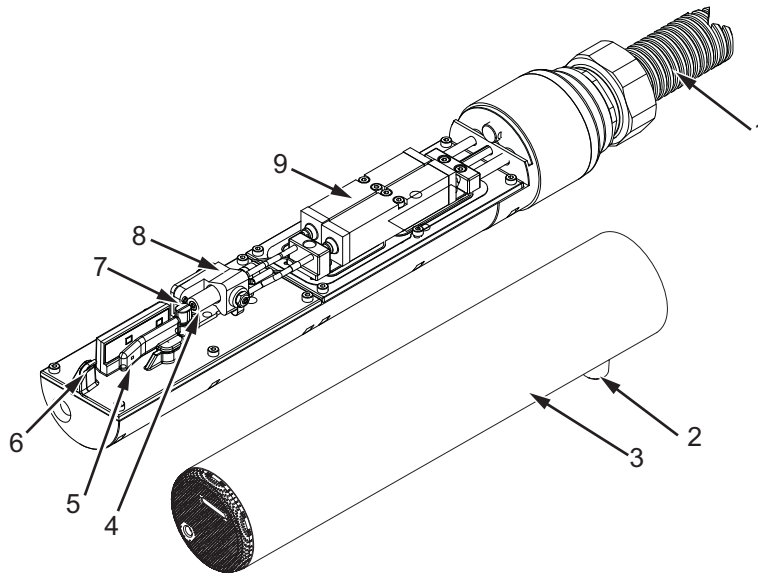

- |                           |                                  |
|---------------------------|----------------------------------|
| <b>1. Umbilical</b>       | <b>6. Gutter Sensing Tube</b>    |
| <b>2. Printhead Screw</b> | <b>7. Charge Electrode</b>       |
| <b>3. Printhead Cover</b> | <b>8. Printhead Engine</b>       |
| <b>4. Nozzle</b>          | <b>9. Printhead Valve Module</b> |
| <b>5. Deflector Plate</b> |                                  |

Figure 6-5: Printhead (Videojet 1520)

- 1 Put the printhead into the wash station (part number 399085).

- 2 Use a cleaning agent and a tissue or a soft brush to clean the following parts of the printhead:

- Gutter Sensing Tube (item 6, Figure 6-4)
- Charge electrode (item 7)
- Deflector plate (item 5) (see “Clean the Deflector Plate” on page 6-10)
- Nozzle (item 4)

*Note:* The cleaning agent must be compatible with the type of ink that you use in the printer.

- 3 Allow the printhead to dry and make sure that the slot in the charge electrode is free of cleaning agent.

*Note:* Use a hand blower or compressed air to dry the printhead quickly. The air pressure must not be more than 20 psi.



### **Caution**

EQUIPMENT DAMAGE. The printhead must be dry before you try to start the printer. The failure to follow this caution can damage the printhead.

---

- 4 Refit the printhead cover and tighten the knurled screw.

## **Clean the Deflector Plate**

To prevent the deposits of ink, clean the contoured surfaces of the deflector plate with the solvent, and clean dry air (CDA).

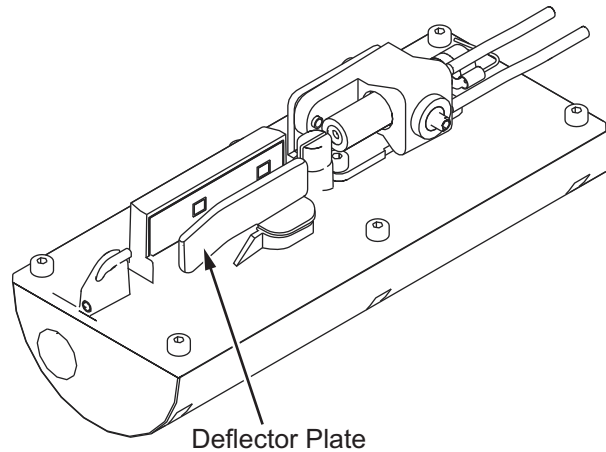

Figure 6-6: Clean the Deflector Plate

## Clean the Printer Cabinet

To clean the printer cabinet, do the following tasks:



### Warning

PERSONAL INJURY. Airborne particles and materials are a health hazard. Do not use high-pressure compressed air to clean the printer cabinet.

- 1 Remove the dust from the printer with a vacuum cleaner, or soft brush.
- 2 Clean the outer surfaces of the printer with a wet lint free cloth.  
Use a mild detergent to remove the contamination that you cannot remove by a wet cloth.

## Introduction

This chapter contains the troubleshooting and fault diagnosis information for the everyday users of the printer.

The service manual has more information on troubleshooting for the service technician and trained personnel.



### Warning

**LETHAL VOLTAGES.** Lethal voltages are present within this equipment when the equipment is connected to the main electrical supply. Only trained and authorised personnel must do the maintenance work. Observe all statutory electrical safety codes and practices. Unless it is necessary to run the printer, disconnect the printer from the main electrical supply before you remove the covers or do any service or repair activity. The failure to follow this warning can cause death or personal injury.



### Warning

**PERSONAL INJURY.** It is possible that in a fault condition the heater can reach 70° C. Do not touch the plate on which heater is installed. The failure to follow this warning can cause the personal injury.

## The Printer Does Not Start

- 1 Make sure that the printer is turned on. To turn on the printer, press the green push button.
- 2 Check the system status LEDs (see Table 7-1) to see if a system fault has occurred or if the user interference is required.

Illuminated	Diagnosis
RED	Any fault that prevents the printing. For example, jet not running, deflector plate trip.
AMBER and GREEN	The printer requires user interference to prevent a system fault. For example, ink or make-up fluid low
GREEN	The printer can print correctly

Table 7-1: System Status LEDs

- 3 If the red or amber LEDs are illuminated, inspect the display to see that icons and related message are displayed. Refer to “Printer Status Icons” on page 7-5.
- 4 If the green LED is illuminated, and the printer does not print:
  - Make sure that the product sensor and shaft encoder are connected and correctly operating (a lamp found behind the product sensor must flash if a product passes the sensor).
  - If the problem continues, report the fault to VTI @ 1-800-843-3610 (within United States only). The customers outside the US must contact a Videojet subsidiary office or the local Videojet distributor.
- 5 If the system status LEDs do not illuminate, check the main electrical supply as follows:
  - a. Make sure that the main electrical supply is available.
  - b. Make sure that the main input connector is fitted correctly.
  - c. Make sure that the main power supply button is in the ON position (looks pressed in).
  - d. If the problem continues, report the fault to VTI @ 1-800-843-3610.



## Incorrect Print Position

- 1 Make sure that the *Product Delay* value set in the *Message Parameters* menu is correct. See “To Set the Message and Default Parameters” on page 5-22.

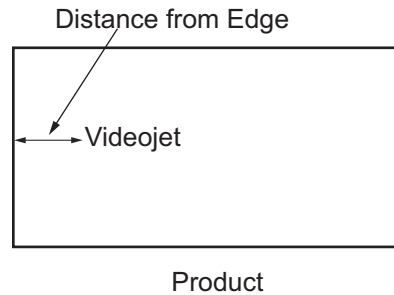

Figure 7-1: Print Position

- 2 Make sure that there are no additional spaces at the start of the message.

## Incorrect Print Size

- 1 Make sure that the set character height is correct. Refer to “To Set Font Height” on page 5-42.
- 2 Make sure that the distance from the printhead to the product is correct. The character height increases and resolution decreases as the printhead moves away from the product.

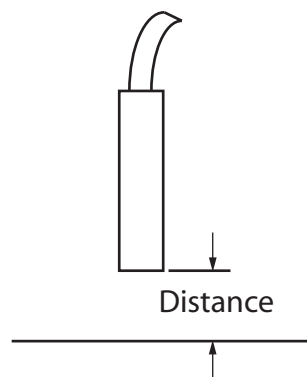

Figure 7-2: Distance from Product

- 3 Make sure that the correct font is selected in the message. Refer to “To Edit a Message” on page 5-20.

**Note:** Refer to Table A-6 on page A-9 for information on the print height.

- 4 If the message width appears stretched, decrease the width value set in the *Message Parameters* menu. Refer to “To Set the Message and Default Parameters” on page 5-22.
- 5 If the message width appears compressed, increase the Width value set in the *Message Parameters* menu.

## Print Not Complete

- 1 Make sure that the *Max Printed Dots* value set in the *Message Parameters* menu is equal to the maximum number of dots required for a raster/ stroke (depends on the model). Refer to “To Set the Message and Default Parameters” on page 5-22. Refer to Appendix A, “Specifications” for more information on the different models of the printer.
- 2 You must check for any ink deposits on the printhead and clean the printhead if necessary. Refer to “Clean the Printhead” on page 6-7.

## Poor Print Quality

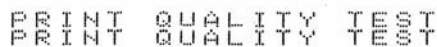

The example on the left shows good overall character formation, no stray drops and an even application of

print.

Table 7-2 describes the samples of bad printing, their causes and the steps required to correct the fault.

Sample and Cause	Remedy
 <p>Jet not aligned correctly, or nozzle has a partial block. Note bottom drops clipping the edge of the gutter. Possible EHT too low.</p>	<p>Clean the printhead. Perform the nozzle flush procedure, wash the nozzle with wash down. Make sure that the gutter is clean.</p>
 <p>Phasing error. The correct placement of drop is not good. You see a good amount of splashing in the area around.</p>	<p>Clean and completely dry the printhead. Make sure there is enough time available between prints to phase.</p>

Table 7-2: Samples of Bad Printing



Sample and Cause	Remedy
 <p>Incorrect modulation, too many satellites, charging process not correct.</p>	Backflush nozzle and check for correct breakup.
 <p>Pressure too high, drops not deflected correctly, drops “run in” to one another, small print.</p>	Check for jet alignment. Refer to the service manual for more information.
 <p>Pressure too low, the drops are over-deflected or incorrectly positioned. Possible loss of most deflected drops.</p>	Check for jet alignment. Refer to the service manual for more information.
 <p>Printhead too far from the substrate. The drops are affected by air currents and are spaced too far apart vertically.</p>	Decrease the distance from the substrate, or select a more correct font.
 <p>The Printhead slot not vertical to the substrate travel.</p>	<p>The face of the of the printhead must be at 90 degrees angle to the surface of the substrate and the slot must be vertical to the substrate movement. Refer to the figure below.</p> 

Table 7-2: Samples of Bad Printing (Continued)

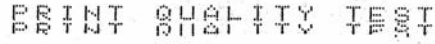
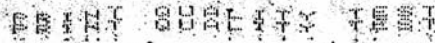
## Printer Status Icons

The printer status icons are divided into three groups:

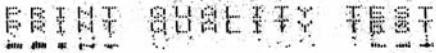
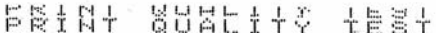
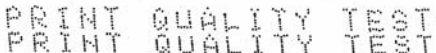
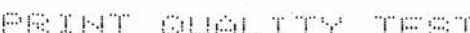
- The indicator icons. The indicator icons show the status of the ink jet.

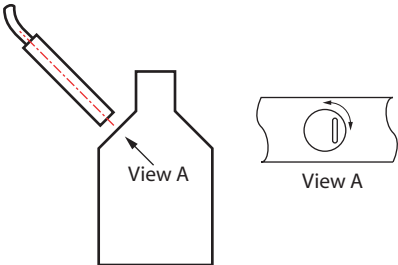
- The fault (alarm) icons. When a fault condition occurs, the prints stops printing.
- The warning icons. When a warning condition occurs, the printer continues to print until the warning condition becomes a fault condition.

## Indicator Icons

Icon	Name	Description
	Jet Running	The ink jet is running and the machine is ready to print. When the machine starts, the icon flashes.
	Jet Stopped	Indicates that the ink jet is stopped.

Table 7-3: Indicator Icons

## Fault (Alarm) Icons

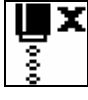

Icon	Name	Remedial Action
	EHT Trip	The deflector plate arcing is sensed. Clean the deflector electrodes, within the printhead. If this action does not correct the fault, contact Videojet maintenance engineer.
	Gutter Fault	Ink is not entering the gutter. Back flush the nozzle. If this action does not correct the fault, report the fault to Videojet maintenance engineer.
	Ink Core Empty	Check whether the ink and make-up cartridges are empty. If the cartridge is empty, then replace it and the ink core is refilled. Check the remaining ink core life. If this action does not correct the fault, report the fault to Videojet maintenance engineer.

Table 7-4: Fault (Alarm) Icons





Icon	Name	Remedial Action
	Pump Fault	Report the fault to Videojet maintenance engineer.
	Cabinet Too Hot	The printer cabinet temperature is more than 80 degrees Celsius. To prevent any damage, the printer stops automatically. The printer starts after the temperature decreases. Report all overheating incidents to Videojet maintenance engineer.
	Ink System Service Overdue	The ink core module is in use for more than 12000 hours and requires maintenance. Refer Table 7-6 on page 7-12 for ink core life. Contact Videojet maintenance engineer.
-	Unable to control viscosity	Check whether the make-up cartridge is not empty. If the cartridge is empty, then replace it. If this action does not correct the fault, report the fault to Videojet maintenance engineer.
-	Mod Driver Chip Over Temperature	Mod amplifier hardware shutdown because of amplifier over temperature. Contact Videojet maintenance engineer.
	Rasters Memory Overflow Detected	Contact Videojet maintenance engineer.
	Valve Error	Hardware error in valve hit / hold drive circuit. Contact Videojet maintenance engineer.
-	Bad Phasing	Phase data cannot be obtained during startup. Contact Videojet maintenance engineer.
-	Modulation Readback Failed	Hardware error. Contact Videojet maintenance engineer.
-	Pump Fault	Pump near max RPM and pressure low. Contact Videojet maintenance engineer.
	Ink Core Expired	The ink core has expired and needs to be replaced.

Table 7-4: Fault (Alarm) Icons (Continued)

## Warning Icons

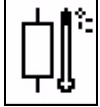



Icon	Name	Remedial Action
	Head Temp Too High	The measured printhead temperature is more than 3° Celsius above the target temperature. Contact Videojet maintenance engineer.
	Incorrect Raster or Raster Family Name	Requested raster table not loaded into system. Contact Videojet maintenance engineer.
	Head Temp Too Low	The measured printhead temperature is more than 3° Celsius below the target temperature. Contact Videojet maintenance engineer.
-	TOF Too High	The measured jet velocity is more than 10% above the target velocity. Contact Videojet maintenance engineer.
-	TOF Too Low	The measured jet velocity is more than 10% below the target jet velocity. Contact Videojet maintenance engineer.
-	No Signal Fault Shutdown	The warning is disabled by entering Service mode and enabled by leaving Service mode.
	Printhead Cover Open	The printhead cover is not closed correctly. The printer continues to run but will not print. If this icon appears when the printhead cover is closed correctly, report the fault to a maintenance engineer
	Phase Threshold Error	The printer is unable to acquire a phase profile with the phase threshold set to the minimum value. Contact Videojet maintenance engineer.
	Ink Viscosity Too High	Pressure setpoint for correct velocity is greater than calculated pressure by > 0.1 bar. Contact Videojet maintenance engineer.
	Ink Viscosity Too Low	Pressure setpoint for correct velocity is less than calculated pressure by > 0.1 bar. Contact Videojet maintenance engineer.

Table 7-5: Warning Icons



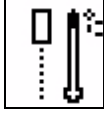

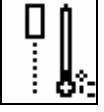
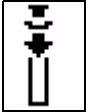
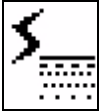
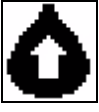

Icon	Name	Remedial Action
	Pressure Too High	The actual pressure is > 0.2 bar above the target pressure. Contact Videojet maintenance engineer.
	Pressure Too Low	The actual pressure is > 0.2 bar below the target pressure. Contact Videojet maintenance engineer.
	No Ink Cartridge	No ink cartridge present. Insert a new ink cartridge.
	Wrong Ink Cartridge	The cartridge inserted into the ink cartridge holder contains the wrong ink type. Fluid REF and fluid TYPE must match ink core module specifications.
-	Ink Cartridge Expired	Ink past expiry date. Insert a new ink cartridge.
	Ink Cartridge Removed	Ink cartridge smartchip data reads no cartridge present. Refit an empty ink cartridge.
-	Ink Insertions Exceeded	The current ink cartridge inserted more than ten times. Insert a new ink cartridge.
	No Make-up Cartridge	No make-up fluid available for addition to the ink core module. Insert a new make-up cartridge.
	Wrong Make-up Cartridge	The cartridge inserted into the make-up fluid cartridge holder contains the wrong make-up fluid type. Insert a new make-up cartridge.
	Make-up cartridge low	Insert a new make-up fluid cartridge. The part number of the make-up fluid is displayed also. If the icon flashes after replenishment, contact a maintenance engineer.
-	Clean Start / Stop Inhibited	Viscosity is too low, so Clean Start / Stop is inhibited to prevent solvent addition. Contact Videojet maintenance engineer.

Table 7-5: Warning Icons (Continued)



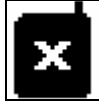

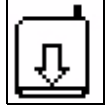

Icon	Name	Remedial Action
-	Makeup Insertions Exceeded	The current make-up cartridge is inserted more than ten times. Insert a new make-up cartridge.
	Ink Core Level High	Ink level in the ink core module is very high. The icon must not be illuminated after a short interval of time. If the icon is displayed for more than 5 minutes, report the fault to a maintenance engineer. Refer to the service manual for more information.
	Ink Core Level Low	Check whether the ink cartridge is empty. If an empty ink cartridge is replaced with a full cartridge while the jet is running, the printer will automatically top-up the core.
	Cabinet Hot	Electronics compartment is above 70 degrees Celsius. Contact Videojet maintenance engineer.
-	Ink Core Insertions Exceeded	The ink core module has been disconnected / reconnected more than ten times. Insert a new ink core module.
	Pump RPM Near Max	Pump RPM setpoint greater than 98% to achieve set pressure. Contact Videojet maintenance engineer.
	No Ink Core	No data from ink core module smartchip - ink core module not plugged in. Contact Videojet maintenance engineer.
	Ink Core Service Soon (0.5% left)	Ink core module nearing end of service life. 0.5% left. Refer Table 7-6 on page 7-12. Contact Videojet maintenance engineer.
	Ink Core Service Soon (2% left)	Ink core module nearing end of service life. 2% left. Refer Table 7-6 on page 7-12. Contact Videojet maintenance engineer.
	Ink core service soon (5% left)	Ink core module nearing end of service life. 5% left. Refer Table 7-6 on page 7-12. Contact Videojet maintenance engineer.

Table 7-5: Warning Icons (Continued)





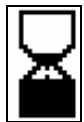
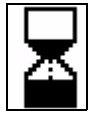



Icon	Name	Remedial Action
	Ink core service soon (10 % left)	Ink core module nearing end of service life. 10% left. Refer Table 7-6 on page 7-12. Contact Videojet maintenance engineer.
-	Ink core will expire in x days	Ink core module nearing end of service life, where x represents number of days remaining. Please contact videojet maintenance engineer to replace.
	Product Delay Too Short	Contact Videojet maintenance engineer.
	Inter-print Gap Too Short	Insufficient time to compile between prints. Contact Videojet maintenance engineer.
	Print Queue Too Deep	Too many products between PEC and the printhead. Contact Videojet maintenance engineer.
	Print Overlap	Print starts before end of current print. Contact Videojet maintenance engineer.
	No Time to Phase	Contact Videojet maintenance engineer.
	No time for TOF	The printer is unable to get an “actual velocity” and thus cannot perform TOF velocity control.
	Overspeed	The Shaft encoder speed is very high to get the print width that you need. If the print width is not acceptable, report the fault to a maintenance engineer.
-	Maximum Print Rate Exceeded	Contact Videojet maintenance engineer.
-	No Valid Ink Parameters	Contact Videojet maintenance engineer.

Table 7-5: Warning Icons (Continued)



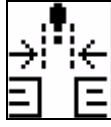

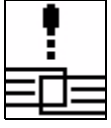
Icon	Name	Remedial Action
-	Possible Ink Coefficient Update	Ink cartridge coefficients do not match ink core module coefficients. Contact Videjet maintenance engineer.
	USB Connection Is Over Current	External USB device requesting excessive current. Contact Videjet maintenance engineer.
-	Suspected Head Heater Failure	Contact Videjet maintenance engineer.
-	Creating Raster Catalog	Software busy. Raster being replaced. Cannot print. Contact Videjet maintenance engineer.
-	Bad Nozzle!!! Please Replace Or Repair	Contact Videjet maintenance engineer.
-	Tank Not Filling	Ink core module still LOW after 5 attempts to add ink to increase level. Contact Videjet maintenance engineer.
	DAC Overflow	hardware fault. Contact Videjet maintenance engineer.
	DAC Comms Error	hardware fault. Contact Videjet maintenance engineer.
	Yellow Beacon Indicator	Message prompts user to refit cartridge.

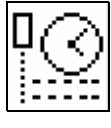
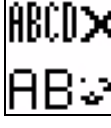
Table 7-5: Warning Icons (Continued)

## Ink Core Life

Videjet 1220	9000 Hours
Videjet 1520	12000 Hours

Table 7-6: Ink Core Life

## **Fault Messages**

Fault messages are displayed at the bottom left of the screen to supplement the printer fault icons. The messages are arranged so that, if more than one fault is found, only the most serious fault message is displayed.

# Specifications

# A

## Electrical Specifications

The electrical specifications of the printer are shown in Table A-1.

Voltage	100 V AC to 240 V AC
Frequency	50 Hz to 60 Hz
Power Consumption	120 watts Maximum

Table A-1: Electrical Specifications

## Weight

The dry weight specification of the printer is shown in Table A-2.

Dry weight	18 kg
------------	-------

Table A-2: Weight Specifications

# Dimensions

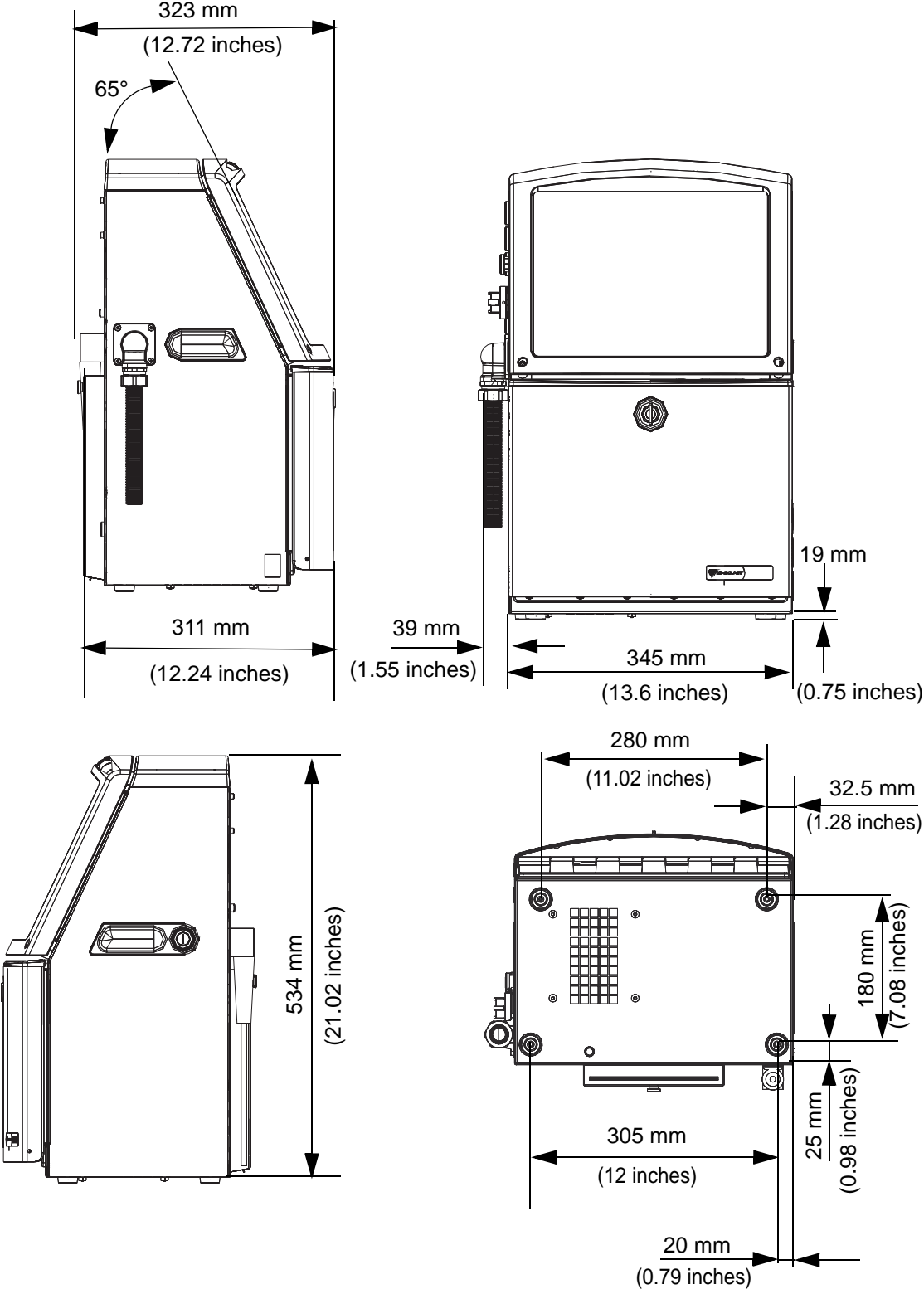
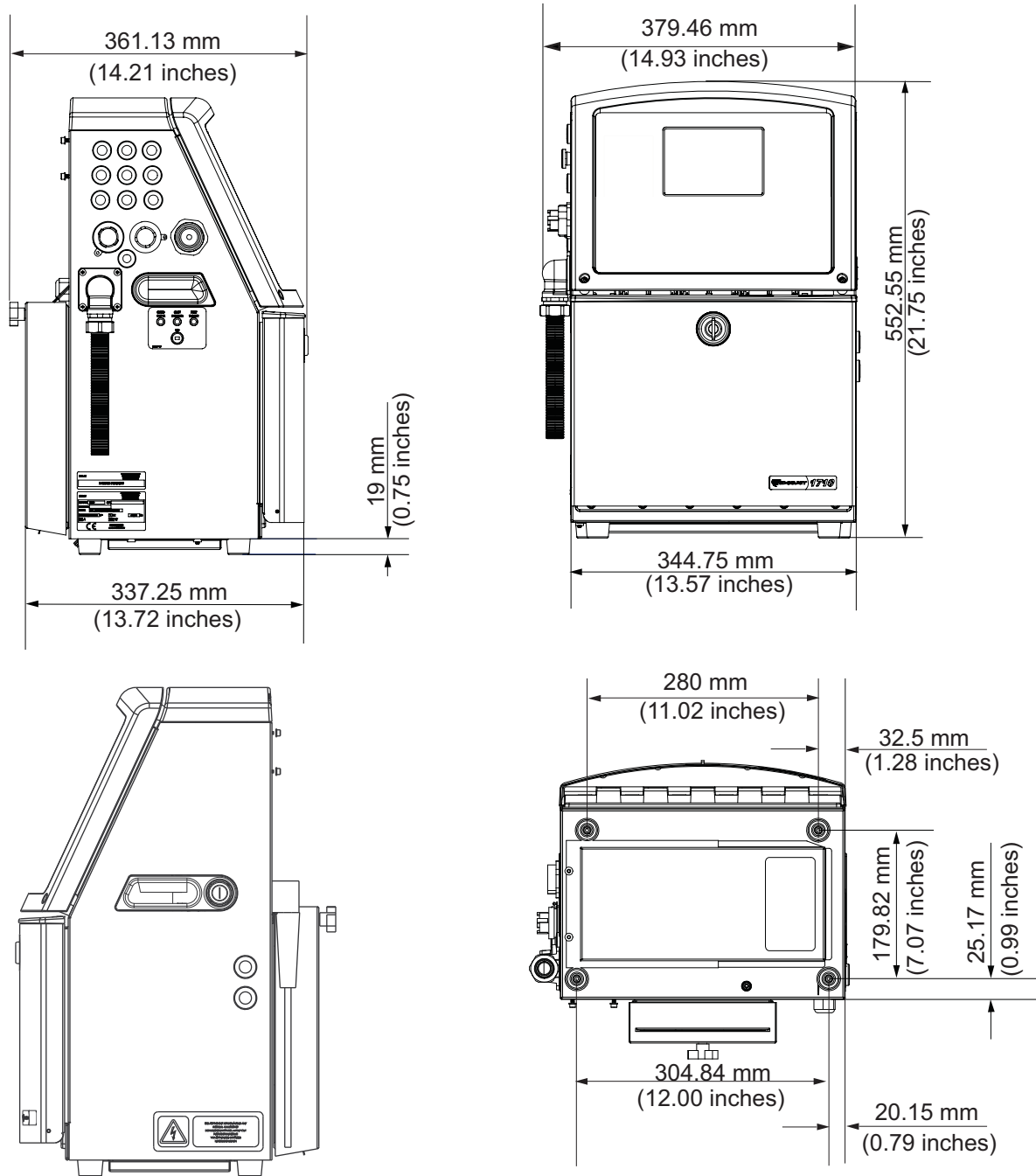

Figure A-1: Printer Dimensions (Videojet 1220)



*Figure A-2: Printer Dimensions (Videojet 1520)*

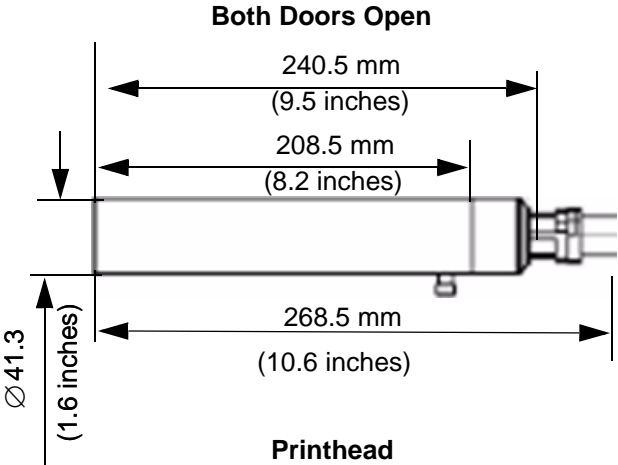
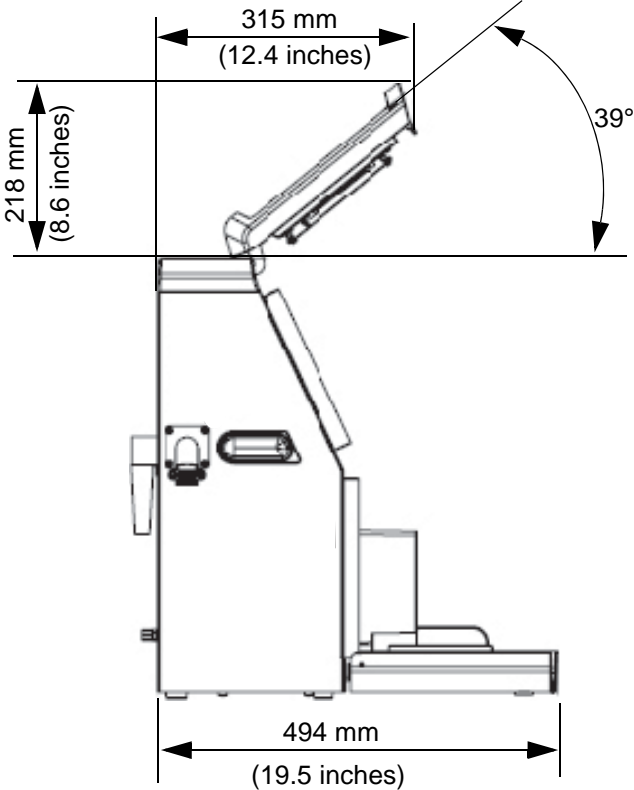

Figure A-3: Printer Dimensions (Videojet 1220) (continued)

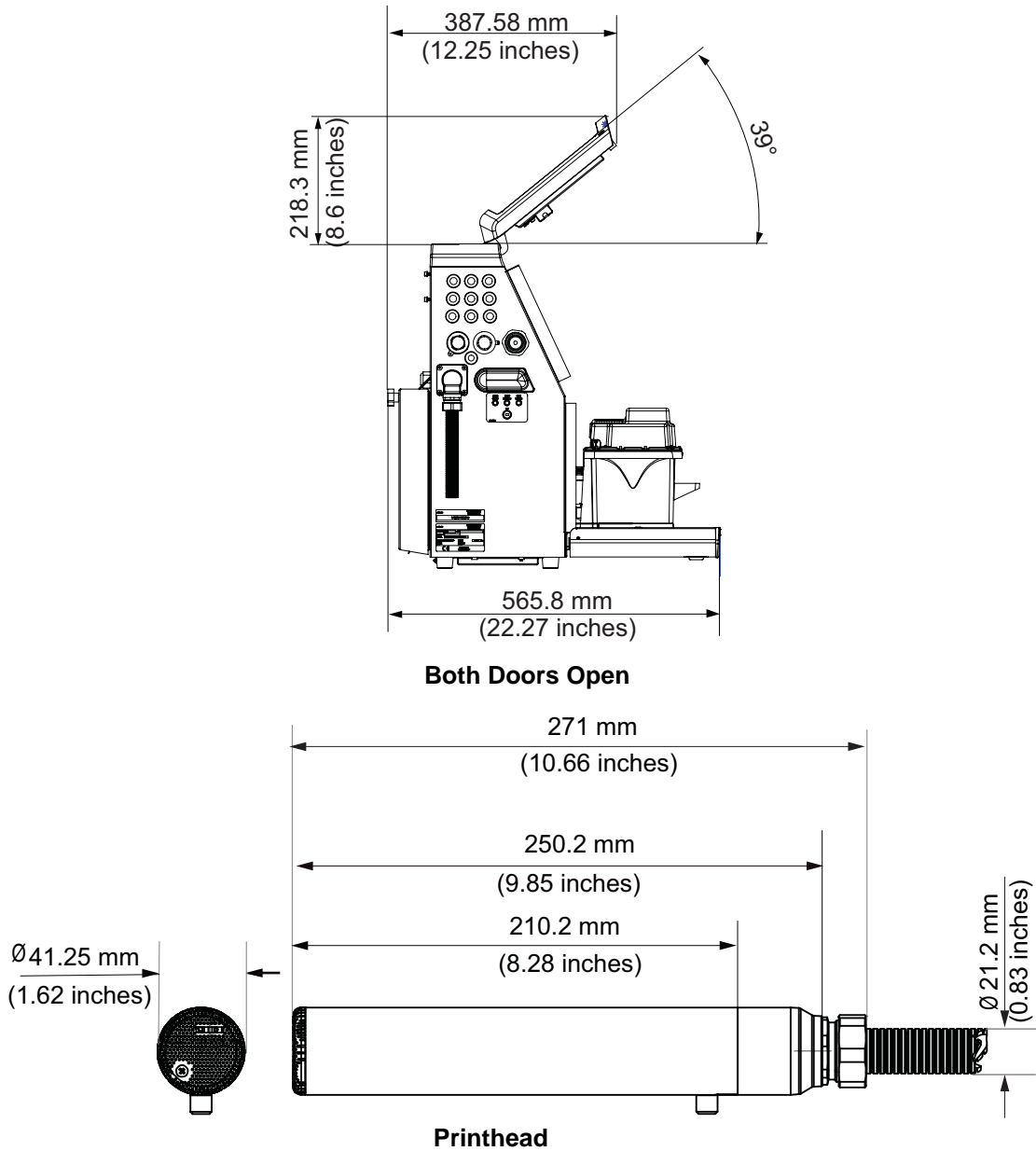

Figure A-4: Printer Dimensions (Videojet 1520) (continued)

The dimensions of the printer are shown in Table A-3.

Cabinet	Width	345 mm
	Height	541 mm
	Depth	285 mm

Table A-3: Printer Dimensions



Printhead	Diameter	Ø41.3
	Diameter of the nozzle orifice	60//70 Microns
Umbilical length	<b>1520</b> 3 Meter Standard 6 Meter Optional <b>1220</b> 2 Meter Standard 3 Meter Optional	-
Cabinet Variations	Standard IP55 (1220/1520) Optional IP65 (1520 Only)	-

Table A-3: Printer Dimensions (Continued)

## Optional Accessories

### Mobile Printer Stand

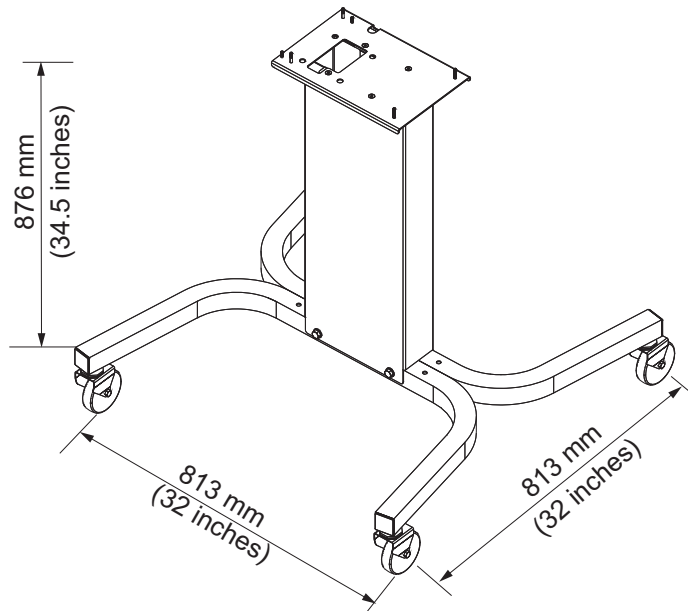

Figure A-5: Mobile Printer Stand

## Static Printer Stand

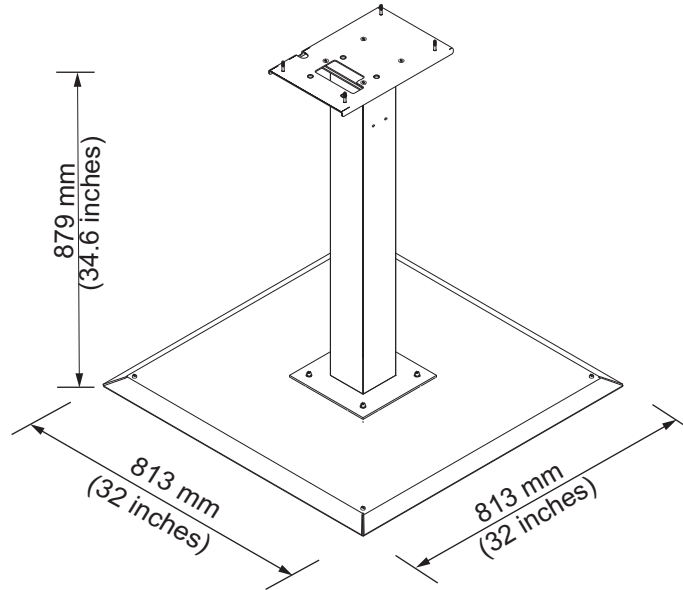

Figure A-6: Static Printer Stand

## Printhead Stand

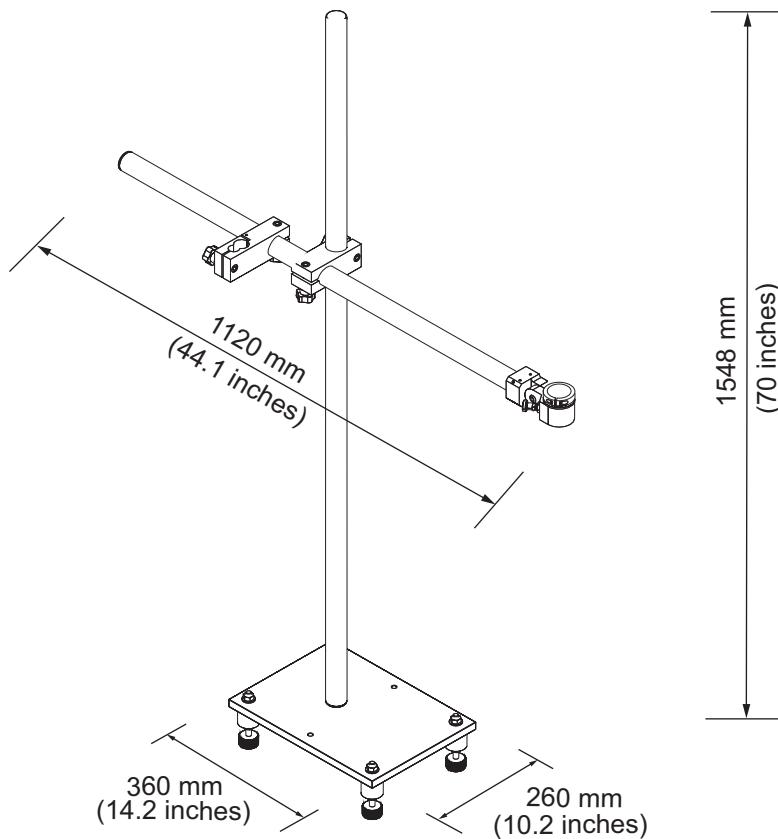

Figure A-7: Printhead Stand

## Environmental Specifications

The environmental specifications of the printer are shown in Table A-4

Operating temperature	5 °C to 45 °C (41 °F to 113 °F)*
Rate of change of ambient temperature	10 °C (18 °F) per hour maximum
Relative humidity	0% to 90 % non-condensing*
Storage temperature	5 °C to 50 °C (41°F to 122 °F) in original packaging
Industrial-protection rating	IP55 is standard for Videojet 1220/1520. IP65 is optional for Videojet 1520 only

Table A-4: Environmental Specifications

**\*Note:** When the printer is operated in an environment with elevated humidity, or with certain inks (including water sensitive inks), air dryers or other items may be required. Please contact Videojet Technologies Inc. customer service department at 800.843.3610 (United States only), or contact the local Videojet Technologies Inc. for more information.

## Ink and Make-up Fluid Capacity

The ink and solvent capacity of the printer are shown in Table A-5.

Ink Cartridge	750 milliliters
Make-up Fluid Cartridge	750 milliliters

Table A-5: Ink and Make-up Fluid Capacity

## Print Height

The minimum and maximum height of the message for the print matrix is shown in Table A-6.

2 mm	Minimum
12 mm	Maximum

Table A-6: Print Height

## Font Specifications and Line Speeds

The font specifications and the line speeds for 60 and 70 micron nozzle are shown in Table A-7 and Table A-8.

**Note:** The optimum value is . The range is 5 to 15 mm.

**Note:** The line speeds listed in the Table A-7 and Table A-9 are for 60 dpi only.

*Note: This table lists the font specification for 1520 model only.*

Line Mode	Height	Width	Cal Speeds			
			70 Micron		60 Micron	
			ft/min	m/min	ft/min	m/min
1	5	5	914	279	914	279
1	7	4	960	293	960	293
1	7	5	800	244	800	244
1	9	7	356	108	356	108
1	12	9	256	78	256	78
1	16	10	200	61	194	59
1	24	16	96	29	96	29
1	34	25	53	16	56	17
2	5	5	256	78	256	78
2	7	4	240	73	320	98
2	7	5	200	61	267	81
2	9	7	119	36	125	38
2	12	9	85	26	85	26
2	16	10	53	16	56	17
3	5	5	119	36	125	38
3	7	4	108	33	108	33
3	7	5	90	27	90	27
3	9	7	53	16	56	17
4	5	5	85	26	85	26
4	7	4	64	20	67	20
4	7	5	53	16	56	17
5	5	5	53	16	56	17

Table A-7: Line Speeds

*Note: This table lists the font specification for 1220 model only.*

Line Mode	Height	Width	Cal Speeds			
			70 Micron		60 Micron	
			ft/min	m/min	ft/min	m/min
1	5	5	533	162	533	162
1	7	5	457	139	457	139
1	9	7	229	70	237	72
1	16	10	194	59	194	59
1	24	16	96	29	96	29
2	5	5	194	59	194	59
2	7	5	194	59	194	59
2	9	7	96	29	96	29
3	5	5	96	29	96	29
3	7	5	90	27	90	27

*Table A-8: Line Speeds*

## Barcode Specifications

The available barcode types are shown in Table A-9.

*Note: Barcode specification and Data Matrix are listed in the Table A-9 and Table A-10. Barcodes run at single line speed based on height selected at 60 dpi.*

Barcode Type
UPCA
UPCE
EAN8
EAN13
Code 128 (A, B and C)
UCC/EAN 128
2 of 5I

*Table A-9: Barcodes Matrix*

Barcode Type
Code 39
2D Data Matrix
2D Data Matrix rectangular (*GS1)

Table A-9: Barcodes Matrix (Continued)

Data Matrix
10 x 10
12 x 12
14 x 14
16 x 16
18 x 18
20 x 20
22 x 22
24 x 24
26 x 26
32 x 32
8 x 18
8 x 32
12 x 26
12 x 36
16 x 36
16 x 48

Table A-10: Data Matrix Code Sizes

**Note:** The 60 Micron Nozzle is recommended to print datamatrix codes at 16 high or taller.

# Glossary

---

## **Character Set**

The character sets are a combination of number of different language alphabets and special text characters that are programmed in the printer.

## **Charge**

The electrical charge that is applied to the small drops of ink. The amount of charge applied depends on the destination of the drop on the substrate.

## **CIJ**

In the CIJ technology a continuous stream of ink breaks into small ink drops, and these ink drops are deflected to form the characters and images on the substrate

## **Clean Start**

Clean start is a printer start sequence which removes the splashing of ink and spray during the startup. This startup sequence is used if Clean Stop was used earlier to stop the printing.

## **Clean Stop**

The Clean Stop feature provides the required time to remove the ink from the manifold and nozzle before the ink jet stops. This action prevents any deposits of ink on the printhead. A clean printer operates correctly for longer periods of time.

## **Deflector Plate**

The deflector plate creates a high voltage field in the printhead. The high voltage field deflects ink droplets for printing. You can change the voltage in the deflector plate to control the character height.

## **Gutter**

The ink not used by the printhead returns through the gutter.

## **Icon**

A graphical symbol used to indicate a printer state or error condition.

## **LCD**

LCD is a thin, flat display device made up of any number of color or monochrome pixels arrayed in front of a light source or reflector.

## **LED**

LED is a semiconductor device that emits visible light when an electric current passes through it.

## **Message Select**

The method to select the message from an external source and not through the keypad. External source like the Programmable Logic Controller (PLC) or a switch box.



**Nozzle**

Ink is supplied to the nozzle assembly and pushed through a small orifice. The nozzle assembly is made to vibrate to break the ink jet into a continuous stream of small drops of ink.

**Parameters**

The settings which are applied to the message that is printed. For example, message width.

**Phasing**

The microprocessor control system of the printer monitors the data from the phase detector. This data make sure that there is synchronization between the charging of small ink drops and their break up.

**Photocell**

A light activated switch that detects the presence of the product to start the printing.

**Product Delay**

The product delay is the time from when the photocell is activated and the message begins to print.

**Quick Start**

Quick Start is used if the machine is turned off for only less than 30 minutes. This start mode of the printer is used where the nozzle is not flushed.

**Quick Stop**

The Quick Stop is used if the machine will be off for less than 30 minutes. This type of stop mode of the printer is used where the nozzle is full of ink.

**RS-232**

Serial data communications standard which enables the communication between the printer and other devices.

**Satellites**

Small additional drops of ink in the ink stream caused by incorrect modulation settings.

**Shaft Encoder**

A device that senses the changes in the product speed and enables the printer to adjust the print width.

**Substrate**

The product surface where the printing occurs.

**User Fields**

A user field is inserted into a message. The user field is copied into the message during the print operation only, so that the user field includes the new updates. (For example, expiry date).

**Valve**

The hydraulic component in the printer to control the flow of ink within the printer.

**Washdown**

A cleaning solution which cleans the printhead and removes any additional deposits of ink.

**WYSIWYG**

WYSIWYG is an acronym for What You See Is What You Get, used in computing to describe a system in which content displayed during editing appears very similar to the final output (in this case, characters and images printed on the substrate).